



CAR-PAK
AUTOMOTIVE BODY MAINTENANCE PARTS
CATALOGUE SUPPLEMENT

FEBRUARY 2009

**ALL NEW PARTS
 JUST RELEASED PAGES 3-6**

**Plus New Items Previously Announced In
 Supplement No. 1 August 2005, No. 2 May 2006,
 No. 3 September 2006 & No. 4 May 2007, No. 5 March 2008**



**SUPPLEMENT NO. 6 TO
 CAR-PAK CATALOGUE 2005**

TABLE OF CONTENTS

SECTION 1

• • • *New Items Not Previously Available* • • •

Numerical Index2
 All New Items For General Motors Products3
 All New Items For Ford Products4
 All New Items For Chrysler Products4
 All New Items For Import Products5
 All New 'Answer' Assortment5
 All New Fuel Line Clips for Ford Products6
 All New Electrical Repair Harnesses8-9

SECTION 2

• • • *Previously Announced New Items* • • •
from Supplement No. 5

New 'Ergolok' Drive Rivets7-8

New Items For General Motors Products . . .9-12 & 30-31
 New Items For Ford Products13-16
 New Items For Chrysler Products16-18
 New General Purpose Items18-21
 All New Caged Nuts20
 New Items For Import Products21-28
 New "C" Charts28-29
 All New Connectors & Seals For Weather Pack . . .31-32
 New X-Ref for Halogen Lamps to C-P Repair Harness .33
 New Electrical Repair Harnesses33-39
 New Ford Lamp Socket Repair Harnesses40-41
 New Ford Lamp Sockets42-45
 Ford Lamp Socket & Repair Harness Appl.45-48



NUMERICAL INDEX

PART #	PAGE #	PART #	PAGE #	PART #	PAGE #	PART #	PAGE #	PART #	PAGE #
76-4379	.21	99-8516	.17	99-8583	.15	99-8650	.17	99-8718	.31
79-5015	.21	99-8517	.28	99-8584	.21	99-8651	.35	99-8719	.31
84-5872	.21	99-8518	.16	99-8585	.21	99-8652	.35	99-8720	.32
86-6091	.33	99-8519	.25	99-8586	.23	99-8653	.35	99-8721	.32
87-6233	.33	99-8520	.21	99-8587	.27	99-8654	.35	99-8722	.32
87-6234	.33	99-8521	.21	99-8588	.12	99-8655	.16	99-8723	.32
87-6235	.33	99-8522	.39	99-8589	.12	99-8656	.10, 15, 17	99-8724	.32
89-6653	.33	99-8523	.13	99-8590	.11	99-8657	.16	99-8725	.32
92-7063	.21	99-8524	.16	99-8591	.14	99-8658	.16	99-8726	.32
92-7064	.21	99-8525	.24	99-8592	.33	99-8659	.17	99-8727	.32
95-7428	.40	99-8526	.19	99-8593	.10	99-8660	.22	99-8728	.32
95-7429	.40	99-8527	.21	99-8594	.36	99-8661	.10, 15, 17	99-8729	.32
95-7448	.21	99-8528	.19	99-8595	.36	99-8662	.16	99-8730	.32
95-7449	.21	99-8529	.28	99-8596	.36	99-8663	.19	99-8731	.19
95-7450	.21	99-8530	.44, 46	99-8597	.26	99-8664	.11	99-8732	.19
95-7451	.21	99-8531	.44, 46	99-8598	.26	99-8665	.9	99-8735	.3
95-7452	.21	99-8532	.41	99-8599	.25	99-8666	.9	99-8736	.3
96-7572	.40	99-8533	.41	99-8600	.25	99-8667	.9	99-8737	.3
96-7573	.40	99-8534	.41	99-8601	.25	99-8668	.9	99-8738	.3
96-7583	.33	99-8535	.41	99-8602	.25	99-8669	.9	99-8739	.3
99-8162	.23	99-8536	.44, 46	99-8603	.10	99-8670	.34	99-8740	.6
99-8213	.20	99-8537	.44, 46	99-8604	.15	99-8671	.4	99-8741	.6
99-8291	.42, 45	99-8538	.44, 46	99-8605	.15	99-8672	.19	99-8742	.3
99-8292	.42, 45	99-8539	.44, 46	99-8606	.15	99-8673	.12	99-8743	.6
99-8293	.42, 45	99-8540	.45, 46	99-8607	.11	99-8674	.12	99-8744	.3
99-8294	.42, 45	99-8541	.43, 46	99-8608	.39	99-8675	.12	99-8745	.3
99-8295	.42, 45	99-8542	.43, 46	99-8609	.10	99-8676	.11	99-8746	.5
99-8296	.42, 45	99-8543	.43, 46	99-8610	.27	99-8677	.27	99-8747	.4
99-8297	.43, 45	99-8544	.12	99-8611	.27	99-8678	.27	99-8748	.3
99-8298	.43, 45	99-8545	.16	99-8612	.38	99-8679	.27	99-8749	.3
99-8299	.43, 45	99-8546	.16	99-8613	.37	99-8680	.27	99-8750	.3
99-8393	.30	99-8547	.22	99-8614	.10	99-8681	.25	99-8751	.3
99-8394	.9	99-8548	.22	99-8615	.26	99-8682	.22	99-8753	.4
99-8460	.22	99-8549	.18	99-8616	.25	99-8683	.12	99-8754	.4
99-8470	.38	99-8550	.16	99-8617	.24	99-8684	.21	99-8755	.5
99-8472	.23	99-8551	.10, 14	99-8618	.24	99-8685	.26	99-8756	.5
99-8473	.24	99-8552	.7, 8	99-8619	.24	99-8686	.26	99-8757	.4
99-8474	.21	99-8553	.10	99-8620	.26	99-8687	.24	99-8758	.5
99-8475	.23	99-8554	.26	99-8621	.34	99-8688	.12	99-8759	.4
99-8476	.23	99-8555	.28	99-8622	.11	99-8689	.12	99-8760	.4
99-8477	.23	99-8556	.28	99-8623	.18	99-8690	.11	99-8761	.6
99-8478	.24	99-8557	.10	99-8624	.18	99-8691	.11	99-8762	.4
99-8481	.39	99-8558	.11	99-8625	.33, 34	99-8692	.25	99-8763	.5
99-8487	.19	99-8559	.11	99-8626	.19	99-8693	.22	99-8766	.4
99-8488	.19	99-8560	.19	99-8627	.10	99-8694	.37	99-8767	.4
99-8489	.13	99-8561	.18	99-8628	.25	99-8695	.7, 8	99-8768	.4
99-8490	.13	99-8562	.17	99-8629	.25	99-8696	.7, 8	99-8769	.4
99-8491	.14, 19	99-8563	.23	99-8630	.25	99-8697	.7, 8	99-8771	.5
99-8492	.26	99-8564	.23	99-8631	.30	99-8698	.7, 8	AN926	.5
99-8493	.26	99-8565	.11, 15	99-8632	.10	99-8699	.8	J01011	.20
99-8494	.26	99-8566	.17	99-8633	.14	99-8700	.8	J01012	.20
99-8495	.26	99-8567	.17	99-8634	.36	99-8701	.8	J01013	.20
99-8500	.25	99-8568	.17	99-8635	.19	99-8702	.34	J01015	.20
99-8501	.27	99-8569	.16	99-8636	.16	99-8703	.15	J01757	.20
99-8502	.27	99-8570	.31	99-8637	.21	99-8704	.34	J03862	.4
99-8503	.12, 24	99-8571	.11	99-8638	.22	99-8705	.24	J03880	.20
99-8504	.24	99-8572	.12	99-8639	.22	99-8706	.24	J06624	.21
99-8505	.23	99-8573	.10	99-8640	.22	99-8707	.20	J06625	.21
99-8507	.24	99-8574	.26	99-8641	.22	99-8708	.20	J06626	.21
99-8508	.39	99-8575	.27	99-8642	.22	99-8709	.20	J06627	.21
99-8509	.33	99-8576	.27	99-8643	.22	99-8710	.20	J06628	.21
99-8510	.23	99-8577	.27	99-8644	.23	99-8711	.15	X-CT-CH	.28
99-8511	.21	99-8578	.7, 8	99-8645	.14	99-8712	.37	X-NT-CH	.29
99-8512	.17	99-8579	.8	99-8646	.14	99-8714	.31	X-RV-CH	.29
99-8513	.17	99-8580	.8	99-8647	.14	99-8715	.31		
99-8514	.18	99-8581	.37	99-8648	.14	99-8716	.31		
99-8515	.17	99-8582	.15	99-8649	.15	99-8717	.31		

LATEST NEW ITEMS FOR GENERAL MOTOR PRODUCTS

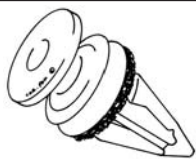

99-8748

Replaces: 11519032
RETAINER-DOOR PANEL

Plastic w/Seal

Hole: M9 Upper Hd: 20MM, O/L: 28MM, Trim Thk: 4.5MM, P.R.: 2.5MM
GM Cars & Lt Duty Trucks, Hummer, Saab, & Saturn 2006/
UNIT PACKAGE 10

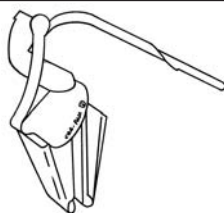

99-8735

Replaces: 4759145, 4761842, 4779348
RETAINER-FRONT & REAR DOOR MOULDING

G.M.

UNIT PACKAGE 15

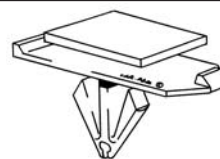

99-8744

Replaces: 11562563
RETAINER-Rocker Moulding
Plastic

Hole: M10, Upper Hd: 12x20MM, P.R.: 4MM, Stem Lgth: 15MM, O/L: 21MM
Chevrolet Malibu 2008/
UNIT PACKAGE 15

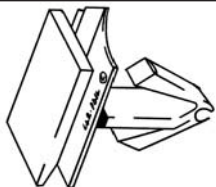

99-8739

Not Supplied by O.E.
RETAINER-ROCKER MOULDING
Plastic-Black

Hole: M9, Upper Head: 12x20MM, P.R.: 8MM, Stem Lgth: 14.8MM
Saturn Aura 2007/
UNIT PACKAGE 15

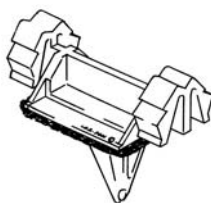

99-8737

Replaces: 11569918
RETAINER-ROOF RAIL MOULDING
Plastic w/Seal

Hole: M7

Buick Terraza & GMC Acadia 2007/
UNIT PACKAGE 15

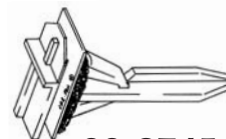

99-8745

Replaces: 11589244, 11569973

RETAINER-Rocker Mldg.,
Spoiler, Interior Roof Trim
Yellow Plastic w/Seal

Hole: M9, Upper Hd: 12x21.5MM, O/L: 42.0MM
G.M. Trucks. Equinox & Torrent 2006/, Enclave, Acadia & Outlook 2004/
UNIT PACKAGE 10

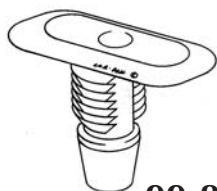

99-8742

Not Supplied by O.E.
RETAINER-FRONT BUMPER
Plastic

Hole: M16, Head: 20x36MM, O/L: 27.5MM
Cadillac STS 2005/
UNIT PACKAGE 15

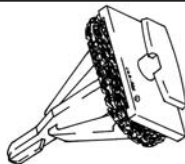

99-8749

Replaces: 10383817, 11610522
RETAINER-SIDE WINDOW REVEAL MOULDING (REAR)
Plastic w/Seal

Hole: M8, Upper Hd.: 6x11MM, O/L: 25MM, P.R.: 2MM, Trim Thk.: 2MM
Buick Lucerne 2006/
UNIT PACKAGE 10

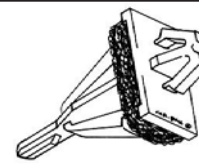

99-8750

Replaces: 11569697
RETAINER-SIDE WINDOW REVEAL MOULDING (REAR)
Plastic w/Seal

Hole: M8, O/L: 29MM, P.R.: 2MM, Trim Thk.: 2MM
Buick Lucerne 2006/
UNIT PACKAGE 5



99-8751

Replaces: 11570512
RETAINER-SIDE WINDOW REVEAL MOULDING
Plastic w/Seal

Hole: M6, O/L: 13MM, P.R.: 1.5MM
Buick Lucerne 2006/
UNIT PACKAGE 10

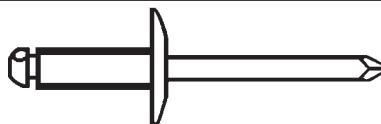

99-8738

Replaces: 11610383
BLIND RIVET-REAR BUMPER PAD
1/4" Rivet, 1/2" Flange,
G.R.: 0.062-0.125
Steel Rivet/Steel Mandrel
GM Lt. Duty Pick UP 2007/ &
General Purpose
UNIT PACKAGE 50



99-8736

Replaces: 11516807
BLIND RIVET-LEG RETENTION STYLE
Bumper, Lic. Plate Brkt.,
Grille, Rocker Moulding
Aluminum Rivet/Aluminum Mandrel
3/16 (M4.8) Rivet, Flange: 5/8 (15.5MM)
G.R.: .040-.354 (1.0-9.0MM)
G.M. Cars & Trucks 2003/
UNIT PACKAGE 25

LATEST NEW ITEMS FOR FORD & CHRYSLER PRODUCTS

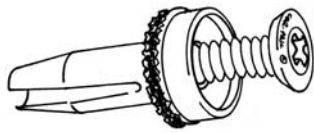

99-8768

Replaces: W713202-S300,
W713445-S300

RIVET-SCREW TYPE, BUMPERS
Plastic w/Seal

Hole: M8, Flange: 13MM,
Stem Lgth: 21MM, P.R.: 3.8-5.0MM
Ford Fusion 2006/
UNIT PACKAGE 15

FORD

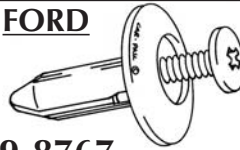

99-8767

Replaces: W706092-S300,
6508197AA, 2028654C1

RIVET-SCREW TYPE,
SHIELDS & GRILLES, Plastic
Hole: M6.4-6.9, Flange: 17.8MM,
Stem Lgth: 18MM, P.R.: 3-5MM

Ford Taurus 2008/
Dodge PU 2002/ & Navistar
UNIT PACKAGE 25



99-8769

Replaces: W713590-S300
RETAINER-WINDSHIELD MOULDING

Plastic-White, w/Seal
Hole: M9, Top Head: 14x18MM,
O/L: 15MM
Ford Flex 2009/
UNIT PACKAGE 15



99-8766

Not Supplied by O.E.

RETAINER-FENDER FLARE
Plastic

Hole: M9, Top Hd: 14x34MM,
Stem Lgth: 13.5MM, P.R.: 0.8-4.0MM
Ford Explorer 2007/
UNIT PACKAGE 25



99-8747

Replaces: 11518988
RETAINER-SLIDING ROOF,
ROOF RACK & SPOILER

Plastic w/Seal
Hole: M9

GM Bravada, Envoy, Trailblazer, SSR,
Acadia & Hummer 2002/
Ford Edge & MKX 2007/
UNIT PACKAGE 15



99-8757

Not Supplied by O.E.

RETAINER-DOOR CLADDING
Plastic, Grey w/Seal

Hole: M9-10, Stem Lgth: 8.5MM
Ford Edge & Lincoln MKX 2007/
UNIT PACKAGE 10

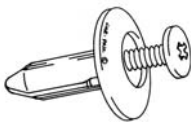

99-8767

Replaces: W706092-S300,
6508197AA, 2028654C1

RIVET-SCREW TYPE,
SHIELDS & GRILLES, Plastic
Hole: M6.4-6.9, Flange: 17.8MM,
Stem Lgth: 18MM, P.R.: 3-5MM

Ford Taurus 2008/
Dodge PU 2002/ & Navistar
UNIT PACKAGE 25

CHRYSLER

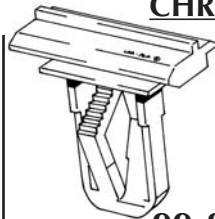

99-8760

Replaces: 5189180AA
RETAINER-Front Fender Flare (Front)
Plastic

Head: 13x31MM, O/L: 29MM
Jeep Commander 2006/
UNIT PACKAGE 15

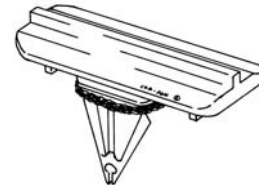

99-8759

Replaces: 5189181AA
RETAINER-Front Fender Flare (Rear)
Plastic w/Seal

Hole: M9-10,
Head:L 14x39MM, O/L: 22MM
Jeep Commander 2006/
UNIT PACKAGE 10



99-8753

Replaces: 6508947AA
RETAINER-FRONT BUMPER
Plastic

Hole: M15, Top Hd: 11x32MM,
O/L: 26MM
Jeep Patriot 2007/
UNIT PACKAGE 10

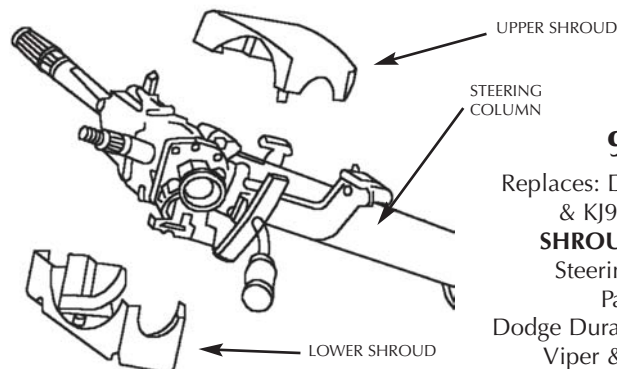

99-8671

Replaces: DH69JX8, DH69JX8AC
& KJ95JX8, KJ95JX8AB

SHROUD-Upper & Lower
Steering Column W/Tilt
Paint to Match

Dodge Durango, Full Size Pick-Up,
Viper & Dakota '97-2002
UNIT PACKAGE 1

LATEST NEW IMPORT PRODUCTS & ASSORTMENTS

AUDI/VOLKSWAGEN

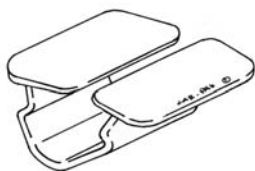

99-8762

Replaces: 1H5-863-849-A01C
RETAINER-HOOD INSULATION
 Plastic - Textured
 Audi & Volkswagen '98/ .
UNIT PACKAGE 15

MERCEDES



99-8754

Replaces: 000-990-84-92
RIVET-DRIVE TYPE, INTERIOR & TRUNK TRIM
 Plastic
 Hole: M6, Flange: 10MM,
 Stem Lgth: 10MM, P.R.: 8MM Max
 Mercedes 'E' & 'C' Class 2001/
UNIT PACKAGE 25

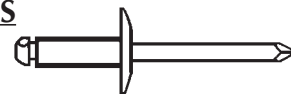

NEW APPLICATION

J03862

Replaces: 003-990-24-97
BLIND RIVET-DOOR HANDLE, AIR BAGS, ROCKER MLD., WINDOW REGULATOR
 Rivet: M4.8(3/16), Flange: 9.5MM(3/8),
 G.R.: 1.6-3.2MM (.063-.125)
 Mercedes Various Models '98/
UNIT PACKAGE 100

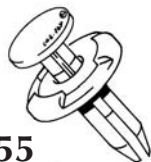

99-8755

Replaces: 01553-05323
RIVET-DRIVE TYPE, COWL, BUMPER, FENDER LINER & ENGINE UNDER COVER - Plastic, Textured
 Hole: M8, Flange: 20MM,
 Stem Lgth: 12MM, P.R.: 2-6MM
 Infinity FX35/45, G35 2003/
 Nissan Cars & Trucks 2004/
UNIT PACKAGE 10

NISSAN

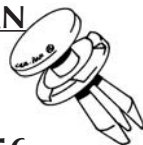

99-8756

Replaces: 66820-AX020
RIVET-DRIVE TYPE, COWL VENT & OUTSIDE MIRROR
 Plastic, Textured
 Hole: M6, Flange: 14MM,
 Head: 13.5MM, Stem Lgth: 10MM,
 P.R.: 5MM Max
 Nissan Versa & Pathfinder 2005/
UNIT PACKAGE 10



99-8771

Not Supplied by O.E.
RETAINER-ROCKER MOULDING
 Plastic
 Hole: M11, Stem Lgth: 9MM,
 O/L: 15MM
 Nissan Murano 2003/
UNIT PACKAGE 10

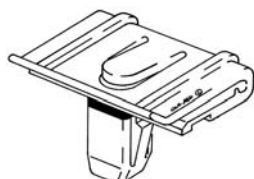

99-8746

Replaces: 90084-46020
RETAINER-BUMPER COVER
 Plastic
 Hole: M9sq.: Top: 23x30MM,
 Stem Lgth: 12MM
 Toyota Avalon, Camry & Solara 2002/
UNIT PACKAGE 10

TOYOTA/LEXUS



99-8758

Replaces: 90189-05142
GROMMET-HEADLAMP MOUNTING
 Plastic
 Hole: M9sq., Flange: 17MM,
 Stem Lgth: 8MM, P.R.: 3MM, Screw:
 M4.2(#8), Sec. Hole: M8
 Toyota Cars & Trucks 2001/
 Scion xB 2004-2006
UNIT PACKAGE 25



99-8763

Replaces: 75547-51021
BLIND RIVET-WINDSHIELD & DRIP MOULDINGS w/Plastic Seal
Rivet-M3.2(1/8"), Flange: 6.4MM(1/4"), Rivet Lgth: 9.5MM(3/8")
Seal-Hole: M4(5/32"), Length: 12MM, Shoulder: 1.5x6.8MM, Flange: 10.4MM
 Aluminum Rivet/Steel Mandrel
 Toyota Land Cruiser 2007/
 Lexus IS250/350 2006/
UNIT PACKAGE 15

FUEL LINE RETAINING CLIP ASSORTMENT

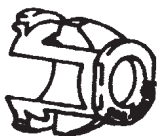
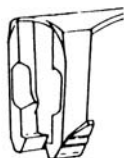

AN926

ASSORTMENT-FUEL LINE RETAINING CLIPS
 11 Items, 40 pcs Total
 Contains: 4 ea 91-6967, 4 ea 91-6968,
 4 ea 91-6972, 2 ea 96-7507, 2ea 96-7508,
 4 ea 96-7575, 4 ea 96-7576, 4 ea 99-8361,
 4 ea 99-8662, 4 ea 99-8740, 4 ea 99-8741
 G.M., Ford & Chrysler
UNIT PACKAGE 1

LATEST NEW ITEMS FOR FORD FUEL LINE CLIPS

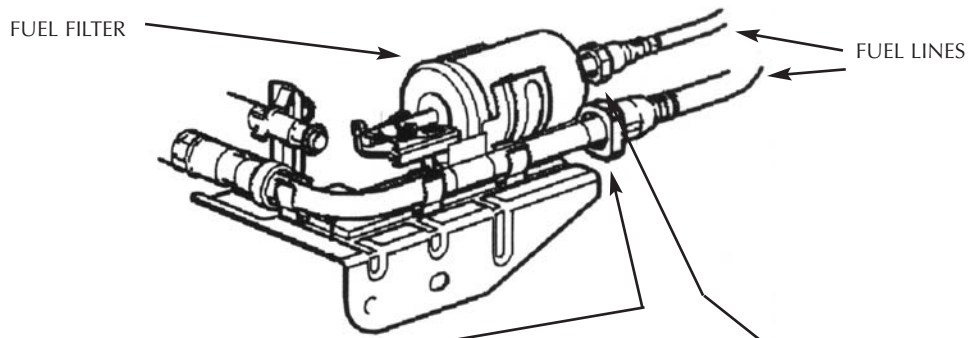

FUEL LINE CLIPS ARE FOUND IN THE FUEL LINE CONNECTOR TO LOCK THE LINE ONTO THE FILTER OR STEEL LINES.

THEY ARE SUSCEPTIBLE TO BREAKAGE WHEN REMOVED WHILE WORKING ON THE FUEL LINE OR FILTER.

99-8741

Replaces: 7L3Z-9S317-B
CLIP-FUEL LINE
 Plastic - Pink
 Fits 3/8" Fuel Line
 Ford F Series Pick Ups 2004/
 UNIT PACKAGE 5

DEALERS, GENERAL REPAIR & BODY SHOPS HAVE HAD DIFFICULTY LOCATING REPLACEMENT CLIPS.

ADDITIONAL FUEL LINE CLIPS CAN BE FOUND ON PAGES 428 & 429 OF THE CAR-PAK CATALOG



99-8740

Replaces: 7L3Z-9S317-A
CLIP-FUEL LINE
 Plastic - Pink
 Fits 5/16" Fuel Line
 Ford F Series Pick Ups 2004/
 UNIT PACKAGE 5

LATEST NEW REPAIR HARNESSSES FOR G.M. PRODUCTS

REPAIR HARNESS

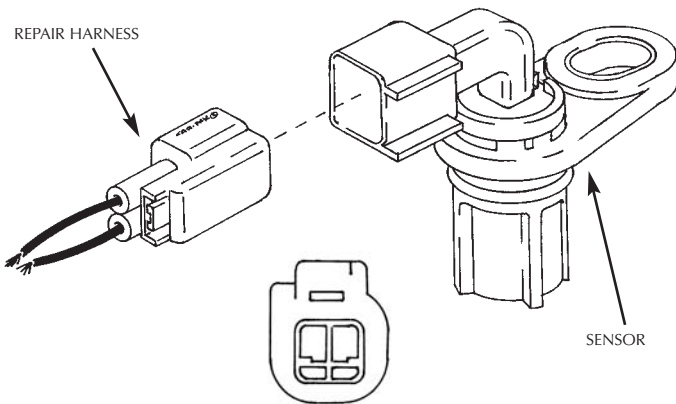

99-8743

Replaces: 3U2Z-14S411-JLA, WPT292,
 5C3Z-14S411-AA, WPT830
REPAIR HARNESS-VEHICLE SPEED SENSOR
 2-16ga TXL 8" Leads
 Sensor #6L3Z-9E731-A, DY-1073
 Ford 'F' Trucks 2004/
also fits Various Relays, Switches, Lamps, Pumps & Motors
 Ford, Lincoln & Mercury Cars & Lt Duty Trucks 2000/
 UNIT PACKAGE 1

LATEST NEW TRAILER CONNECTOR

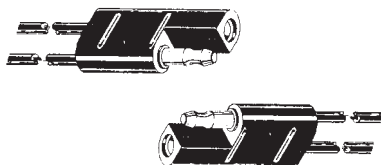

99-8761

HARNESS-TRAILER CONNECTOR
 2- Connectors
 1-Female & 1 Male
 Formerly J03367
 UNIT PACKAGE 10

EXPANDED SERIES OF ERGOLOK DRIVE RIVETS

LOWER INSTALLATION EFFORT
GOOD RETENTION
CONSISTENT THROUGHOUT PANEL RANGES
WIDE HOLE DIAMETER RANGES
REUSABLE
HIGH SHEAR STRENGTH

CAR-PAK ALWAYS PROVIDES
THE MOST CURRENT APPLICATION INFORMATION
SO YOU CAN MAKE INFORMED
PURCHASING DECISIONS

UPDATED
APPLICATIONS

UPDATED
APPLICATIONS

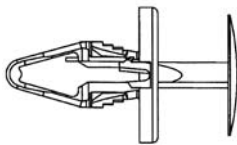

99-8696

Replaces: 11589289, 6508863AA
**RIVET-DRIVE TYPE, FLARES, COWL,
ROCKER MOULDING, Plastic**
Hole: M6.25-6.53, Flange: 18MM,
Stem Lgth: 17.5MM, P.R.: 2-4MM
G.M. Equinox & Torrent 2007,
Buick Enclave, Saturn '91/ & Chrysler
UNIT PACKAGE 25

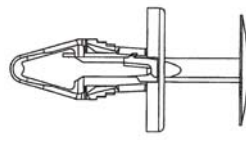

99-8578

Replaces: 11589290, W714040-S300
**RIVET-DRIVE TYPE,
COWL VENT & BUMPER, Plastic**
Hole: M6.25-6.53, Flange: 18MM,
Stem Lgth: 20MM, P.R.: 4.5-7.0
G.M. 'A' 'W', 'L', 'M', G5 Body 2005/
C/K Truck & SUV 2007/, Saturn Sky
2007/, Ford Flex 2009
UNIT PACKAGE 50

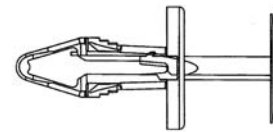

99-8695

Replaces: 11589291, W713331-S300
**RIVET-DRIVE TYPE,
AIR DAM & GRILLE
Plastic**
Hole: M6.25-6.53, Flange: 18MM,
Stem Lgth: 22MM, P.R.: 7-9.5MM
G.M. 2006/ & Ford
UNIT PACKAGE 25

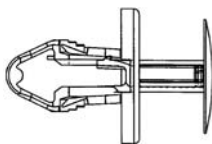

99-8697

Replaces: 15296830, 5116530AA
**RIVET-DRIVE TYPE,
FLARES & PANELS
Plastic**
Hole: M7.75-8.25, Flange: 19MM,
Stem Lgth: 16MM, P.R.: 5-7MM
G.M. & Dodge Caliber & Charger, Jeep
Patriot 2006/
UNIT PACKAGE 25

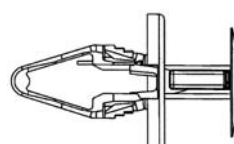

99-8698

Replaces: 11589292
**RIVET-DRIVE TYPE,
AIR DAM, FENDER FLARES/APRON
Plastic**
Hole: M8.25-8.53, Flange: 20MM,
Stem Lgth: 20MM, P.R.: 2-4.5MM
G.M. Full Size Pick Up & SUV 2006/,
Cadillac Escalade 2007/
UNIT PACKAGE 25

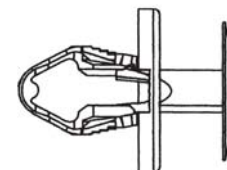

99-8552

Replaces: 11609417
**RIVET-DRIVE TYPE, FENDER APRON
Plastic**
Hole: M8.25-8.53, Flange: 19MM,
Stem Lgth: 14MM, P.R.: 2.7-5.3MM
G.M. Cobalt, G5 2005
Avalanche, Escalade & Acadia 2007/
UNIT PACKAGE 50

SECTION 2: PREVIOUSLY ANNOUNCED ITEMS
NEW ERGOLOK DRIVE RIVETS FOR G. M., FORD, CHRYSLER & GENERAL PURPOSE PRODUCTS

NEW ERGOLOK DRIVE RIVETS

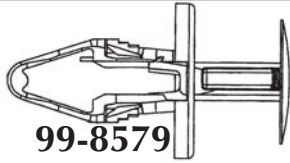

99-8579

Replaces: 11589293, W712196-S300
RIVET-DRIVE TYPE,
 COWL VENT, FENDER & BUMPER Plastic
 Hole: M8.25-8.53, Flange: 20MM,
 Stem Lgth: 21.5MM, P.R.: 4.5-7.0
 G.M. 'W', 'N' Body & Hummer 2005/
 Full Size SUV & Suburban 2007/
 Ford Edge/MKX 2007/, Flex 2009
 Fusion/MKZ/Zephyr/Milan2006/
UNIT PACKAGE 25

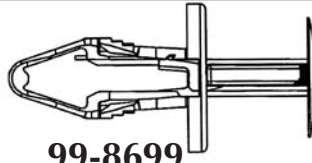

99-8699

Replaces: 11589294
RIVET-DRIVE TYPE,
 FENDERS & BUMPERS, Plastic
 Hole: M8.25-8.53, Flange: 20MM,
 Stem Lgth: 24MM, P.R.: 7.0-10MM
 Buick LaCrosse/Allure 2005/, Chevrolet
 Traverse 2009
 G.M. C/K Trucks, SUV's Hummer 2007/
UNIT PACKAGE 25

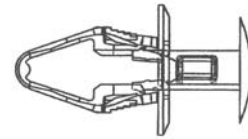

99-8580

Replaces: 11561368, 6508712AA
RIVET-DRIVE TYPE,
 FENDER, WHEEL & BUMPER
 Plastic
 Hole: M9.25-9.53, Flange: 18MM,
 Stem Lgth: 20MM, P.R.: 3.0-5.7MM
 G.M. 'W' & 'M' Body 2006,
 Jeep Wrangler 2006/
UNIT PACKAGE 25

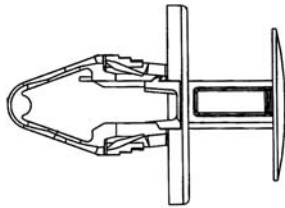

99-8700

Replaces: 11589295, 5GUU9K111BA,
 W712665-S300
RIVET-DRIVE TYPE,
 FUEL TANK & BRAKES, Plastic
 Hole: M10.25-10.53, Flange: 25MM,
 Stem Lgth: 20MM, P.R.: 3-6MM
 G.M. HHR, G5, G6 & C/K TRUCKS 2005/
 Saturn Vue 2008/, Saab 9-3 2008
 Chrysler & Ford
UNIT PACKAGE 25

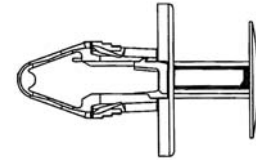

99-8701

Replaces: 11589296
RIVET-DRIVE TYPE,
 FENDER APRON
 Plastic
 Hole: M10.25-10.53, Flange: 25MM,
 Stem Lgth: 23MM, P.R.: 6.0-9MM
 G.M. 2007/
UNIT PACKAGE 25

USE THE SIZE CHART FOR UNIVERSAL APPLICATIONS

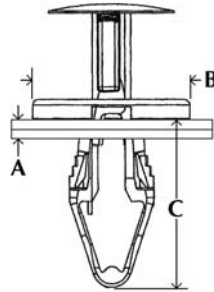

C-P #	HOLE	A PANEL RANGE	B FLANGE	C STEM LENGTH
99-8696	M6.25-6.53	2.0-4.5MM	18.0MM	17.5MM
99-8578	M6.25-6.53	4.5-7.0MM	18.0MM	20.0MM
99-8695	M6.25-6.53	7.0-9.5MM	18.0MM	22.0MM
99-8697	M7.75-8.03	5.0-7.0MM	19.0MM	16.0MM
99-8698	M8.25-8.53	2.0-4.5MM	20.0MM	20.0MM
99-8552	M8.25-8.53	2.7-5.3MM	19.0MM	14.0MM
99-8579	M8.25-8.53	4.5-7.0MM	20.0MM	21.5MM
99-8699	M8.25-8.53	7.0-10.0MM	20.0MM	24.0MM
99-8580	M9.25-9.53	2.95-5.75MM	18.0MM	20.0MM
99-8700	M10.25-10.53	3.0-6.0MM	25.0MM	20.0MM
99-8701	M10.25-10.53	6.0-9.0MM	25.0MM	23.0MM

NEW ITEMS FOR GENERAL MOTORS PRODUCTS

LATEST 2 PIECE G.M. DOOR/TRIM PANEL RETAINERS

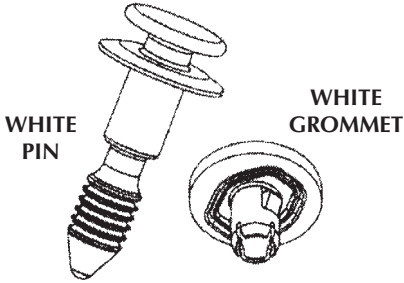
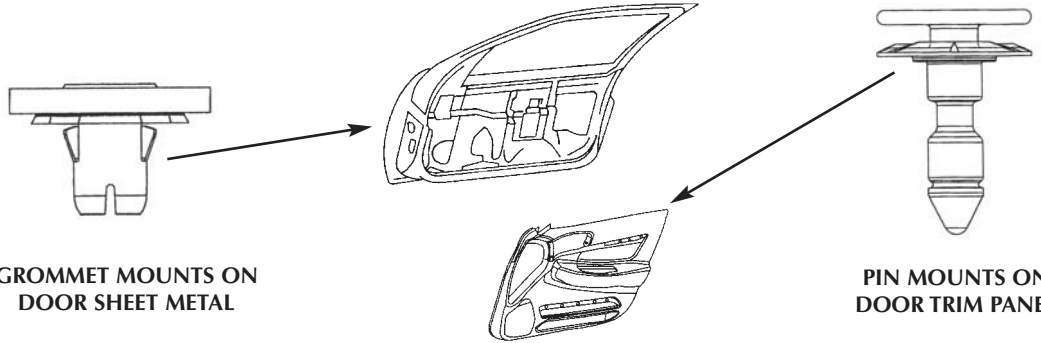

99-8394

Replaces: 22699649, 22704458, 22713392, 11562287, 10363811
RETAINER- DOOR PANEL
 Plastic
 Contains: 25-22722859 & Pins & 25-22722860 Grommets w/Seal
White Grommet-Hole: M9, Flange Dia: 24MM, P.R.: 1MM
White Pin-Upper Hd: 13MM, O/L: 32MM, Trim Thk: 3MM
 Pontiac Grand Am & Oldsmobile Alero 2002/
UNIT PACKAGE 25

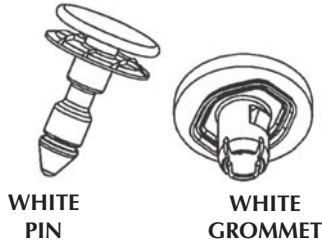

99-8665

Replaces: 11562043
RETAINER-DOOR PANEL
 Plastic
 Contains: 15-11561499 Pins & 15-22722860 Grommets w/Seal
White Grommet-Hole: M9, Flange Dia: 24MM, P.R.: 1MM
White Pin-Upper Hd: 19.5MM, O/L: 28MM, Trim Thk: 2.2MM
 Cadillac STS, SRX 2004/, Hummer H3 2006/ & Chevrolet Cobalt, HHR 2006/
UNIT PACKAGE 15

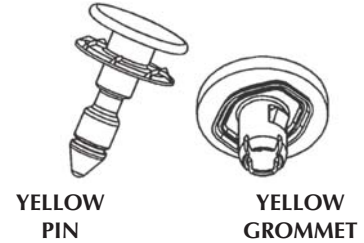

99-8666

Replaces: 11562044
RETAINER-DOOR PANEL
 Plastic
 Contains: 15-11561600 Pins & 15-11561500 Grommets w/Seal
Yellow Grommet-Hole: M9, Flange Dia: 24MM, P.R.: 1.7-1.9MM
Yellow Pin-Upper Hd: 19.5MM, O/L: 30MM, Trim Thk: 4.2MM
 Cadillac STS, SRX 2004/, Hummer H3 2006/ & Chevrolet Cobalt, HHR 2006/
UNIT PACKAGE 15

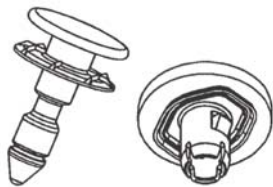

YELLOW PIN **WHITE GROMMET**

99-8667

Replaces: 11562288
RETAINER-DOOR PANEL
 Plastic
 Contains: 15-11561600 Pins & 15-22722860 Grommets w/Seal
White Grommet-Hole: M9, Flange Dia: 24MM, P.R.: 1MM
Yellow Pin-Upper Hd: 19.5MM, O/L: 30MM, Trim Thk: 4.2MM
 Hummer H2 2006/
UNIT PACKAGE 15

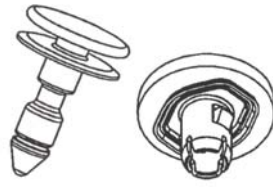

BLACK PIN **WHITE GROMMET**

99-8668

Replaces: 11562256
RETAINER-DOOR PANEL
 Plastic
 Contains: 15-11562241 Pins & 15-22722860 Grommets w/Seal
White Grommet-Hole: M9, Flange Dia: 24MM, P.R.: 1MM
Black Pin-Upper Hd: 19.5MM, O/L: 28MM, Trim Thk: 2.95MM
 GM Full Size Vans 2005/ & Chevrolet Cobalt, HHR 2006/
UNIT PACKAGE 15

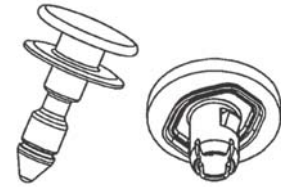

GREEN PIN **YELLOW GROMMET**

99-8669

Replaces: 11562257
RETAINER-DOOR PANEL
 Plastic
 Contains: 15-11562242 Pins & 15-11561500 Grommets w/Seal
Yellow Grommet-Hole: M9, Flange Dia: 24MM, P.R.: 1.7-1.9MM
Green Pin-Upper Hd: 19.5MM, O/L: 30MM, Trim Thk: 4.95MM
 Chevrolet Cobalt, HHR 2006/
UNIT PACKAGE 15

NEW ITEMS FOR GENERAL MOTORS PRODUCTS

NEW ITEMS FOR GENERAL MOTORS PRODUCTS



99-8573

Replaces: 15288146, 15893516
RETAINER-WINDSHIELD PILLAR
 Moulding
 Plastic w/Seal
 Hole: M9
 Chevrolet Equinox 2005/
UNIT PACKAGE 15

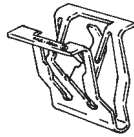

99-8632

Replaces: 11588650
CLIP- W/S GARNISH, INTERIOR TRIM
 PANELS, BEZELS & SCUFF PLATES
 G.M. Cars, Lt Duty Trucks &
 Hummer 2002/
UNIT PACKAGE 10



99-8557

Replaces: 5482103
RETAINER-COWL VENT
 Plastic w/Seal
 Hole: M7, Upper Head: 13MM,
 O/L: 18MM
 Chevrolet Equinox 2005
UNIT PACKAGE 10



99-8609

Replaces: 15078238, 15033681
CLIP-COWL VENT, RADIATOR GRILLE
 & BUMPER COVER
 Slot: 8x25.4MM, Flange: 16.5x25MM
 G.M. C/K Pick-Up/SUV,
 Trailblazer/Envoy & 'G' Vans '99/
 G.M. Hummer H2 2002/
UNIT PACKAGE 15

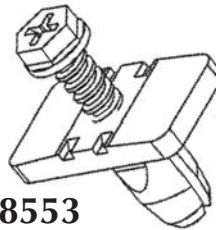

99-8553

Replaces: 12337831
RIVET-SCREW TYPE, FRONT BUMPER
 Plastic
 Hole: M8, Flange: 14x26MM,
 Stem Lgth: 14MM, P.R.: 3-6MM
 Pontiac G6 2005
UNIT PACKAGE 50



99-8661

Replaces: 14083173, 17988488,
 17997722, 25536302, N803685-S
NUT-SNAP IN STYLE
 Front Bumper, Side/High Stop Lamps,
 Rear Wheel
 Flare & Interior Trim/Dash Mountings
 Screw: M4.2 (#8), Hole: 9x11MM
 G.M., Saturn, Hummer, Ford & Jeep '82/
UNIT PACKAGE 25

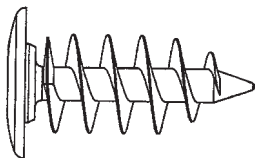

99-8656

Not Supplied by O.E.
SCREW-BUMPER & DOOR INSULATORS
 Plastic, Truss Head
 Hole: M12, Head: 22MM, O/L: 36MM,
 Thread Dia.: 14MM, Drive: #3 Square
 G.M., Ford & Chrysler 2005/
UNIT PACKAGE 25

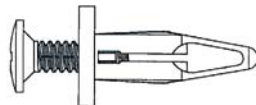

99-8614

Replaces: 15014352
RIVET-SCREW TYPE, COWL VENT
 Plastic
 Hole: M7, Flange: 14MM,
 Stem Length: 23MM, P.R.: 4.5-5MM
 Buick Lucerne 2006
UNIT PACKAGE 15

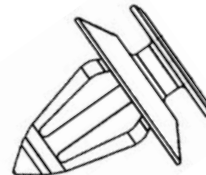

99-8593

Replaces: 90321122
RETAINER-DOOR PANEL
 Plastic
 Hole: M7.4, Upper Hd: 13MM, O/L:
 19MM,
 Trim Thk: 2.5MM, P.R.: 0.7MM
 Saturn Ion 2003/
UNIT PACKAGE 50



99-8551

Replaces: 10293193, N811040-S
RETAINER-HOOD INSULATOR,
 Door w/Strip
 Plastic
 Hole: M7, Head: 12.6MM,
 Stem Lgth: 15MM,
 P.R.: 0.8-8.0MM, O/L: 17.5MM
 Chevrolet Cobalt 2005, Ford Mustang 2005/
UNIT PACKAGE 50

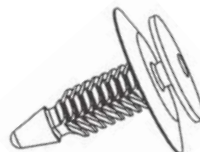

99-8627

Replaces: 11588863
RETAINER-DOOR PANEL
 Plastic
 Hole: M7, Head: 18MM,
 O/L: 29.5MM, P.R.: 1.5-11.5MM
 G.M. Terraza, Uplander,
 Montana & Relay 2005/
UNIT PACKAGE 25

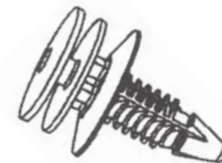

99-8603

Replaces: 10305191
RETAINER-REAR DOOR PANEL
 Plastic
 Hole: M7, Upper Head: 18MM,
 O/L: 29MM,
 P.R.: 1.0-7.5MM, Trim Thk: 2.75MM
 Chevrolet Impala 2000/
UNIT PACKAGE 50

NEW ITEMS FOR GENERAL MOTORS PRODUCTS

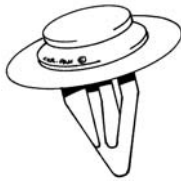

99-8690

Replaces: 22691056
RETAINER-TAILGATE MOULDING
 Plastic, W/Seal
 Hole: M 9, Head: 13MM,
 Flange: 25MM, O/L: 20MM
 G.M. Avalanche & Escalade EXT 2007
UNIT PACKAGE 15



99-8565

Replaces: 4001934, 7642589, W709883-S300
RETAINER-FIRE WALL INSULATOR, ROCKER MOLDING
 Plastic
 Formerly 72-3642
 Hole: M9.65, Head: 25.4mm, Stem Lgth: 36MM
 G.M. '68/ & Ford Mustang 2005/
UNIT PACKAGE 50



99-8590

Replaces: 11561655, 11609862
RETAINER-REAR LAMP MOUNTING
 Plastic w/Seal
 Hole: M11, Flange: 15MM, O/L: 19MM
 Buick Terraza, Chevrolet Uplander,
 Pontiac Montana SV6, Saturn Relay 2005/
UNIT PACKAGE 5

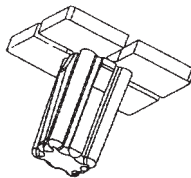

99-8607

Replaces: 22546934
GROMMET-LICENSE PLATE
 Plastic
 Hole: M8sq., Flange: 20MM, O/L: 16.5MM,
 P.R.: 0.75 or 2.15MM, Screw M6.3 (1/4")
 Chevrolet Malibu 2004/
UNIT PACKAGE 50

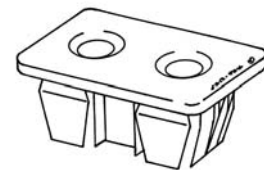

99-8676

Replaces: 10266978
GROMMET-License Plate
 Plastic
 Hole: 10x27MM, Flange: 17x33MM,
 Screw: #14(M6.3)
 GM 'U', 'W', 'L' & 'X' Bodies '97/
UNIT PACKAGE 15



99-8691

Replaces: 11561382, 11610198
GROMMET-TAIL LAMPS
 Plastic w/Seal
 Slot: 9x16MM, Flange: 13x20MM,
 O/L: 19MM
 G.M. 'Z' cars, S/T & 'U' Trucks 2002/
 Pontiac G6 2005
UNIT PACKAGE 10

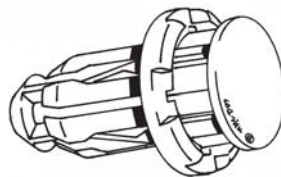

99-8558

Replaces: 5480772
RIVET-DRIVE TYPE,
 Lower Rocker Moulding
 Plastic
 Hole: M15, Flange: 22MM, O/L: 26.5MM
 Chevrolet Equinox 2005
UNIT PACKAGE 10



99-8622

Replaces: 11561491, 15872008
RETAINER-ROCKER MOLDING
 Plastic
 Hole: M15, Stem Lgth: 11.3MM
 (Replaces original Stem Lgth. of 19MM)
 Chevrolet Equinox 2006
UNIT PACKAGE 10

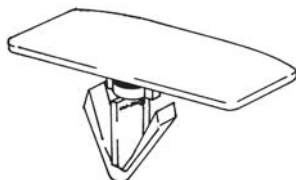

99-8559

Replaces: 10437565, 10352803
RETAINER-ROCKER MOULDING
 Plastic
 Hole: M7, Head: 12x33MM,
 Stem Lgth: 17.5MM
 Chevrolet Impala ('W' body) 2000/
UNIT PACKAGE 10

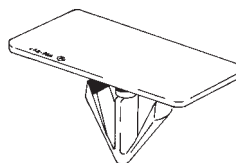

99-8571

Replaces: 10426887, 10431503, 10352809
RETAINER-ROCKER MOULDING
 Plastic
 Hole: M7, Head: 17x33MM,
 P.R.: 5.5-6.5MM
 G.M. 'W' Bodies 2000/
UNIT PACKAGE 25

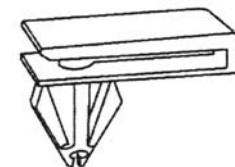

99-8664

Replaces: 15221959
RETAINER-ROCKER PANEL
 Plastic
 Hole: M10, Head: 15x29MM,
 Stem Lgth: 15MM
 Chevrolet Cobalt, HHR 2005/
 & Pontiac G5 2007
UNIT PACKAGE 15

NEW ITEMS FOR GENERAL MOTORS PRODUCTS

NEW ITEMS FOR GENERAL MOTORS PRODUCTS



99-8572

Replaces: 5480852
RETAINER-ROCKER MOULDING
 Plastic w/Seal
 Hole: M9
 Chevrolet Equinox 2005/
 UNIT PACKAGE 15

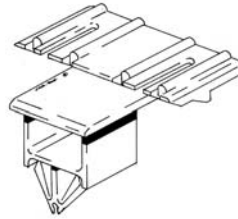

99-8673

Replaces: 10384814
RETAINER-Rocker Molding
 Plastic-White
 Hole: M10
 Buick Lucerne 2006
 UNIT PACKAGE 10

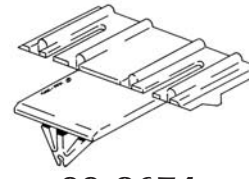

99-8674

Replaces: 15236893
RETAINER-Rocker Molding
 Plastic-Black
 Hole: M9
 Buick Lucerne 2006
 UNIT PACKAGE 10



99-8675

Replaces: 15236894
RETAINER-Rocker Molding
 Plastic
 Hole: M9
 Buick Lucerne 2006
 UNIT PACKAGE 10



99-8688

Replaces: 11589176
RETAINER-ROCKER MOULDING
 Plastic
 Hole: M9, Top: 19x26MM,
 Bottom: 15x25MM
 Chevrolet Malibu 2004/
 UNIT PACKAGE 15



99-8588

Replaces: 15127746
RETAINER-BODY SIDE MOULDING
 Plastic
 Hole: M9, Head: 12x20MM,
 Stem Lgth: 11MM
 Buick Terraza, Chevrolet Uplander,
 Pontiac Montana SV6, Saturn Relay 2005/
 UNIT PACKAGE 15

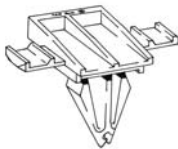

99-8589

Replaces: 15116576, 1151665, 15282120
RETAINER-BODY SIDE MOULDING
 Plastic
 Hole: M10, Head: 16x38MM,
 Stem Lgth: 15MM
 Buick Terraza, Chevrolet Uplander,
 Pontiac Montana SV6, Saturn Relay 2005/
 UNIT PACKAGE 15

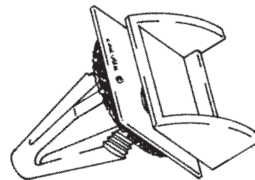

99-8544

Replaces: 10297370
RETAINER-BODY & FENDER
MOULDINGS
 Plastic w/Seal
 Hole: M11
 G.M. 'U' Vans & Hummer '97/
 UNIT PACKAGE 10

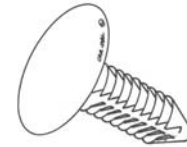

99-8683

Replaces: 24501057
RETAINER-FENDER APRON
& RADIATOR BAFFLE
 Plastic
 Hole: M8, Head: 25.4MM,
 Stem Lgth: 18.7MM, P.R.: 2.8-13MM
 GM Denali, Escalade, Tahoe &
 Yukon 2003/, Hummer H3 2006/
 UNIT PACKAGE 25

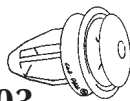

99-8503

Replaces: 82315-38000, 94530565
RETAINER-DOOR & INTERIOR
TRIM PANEL
 Plastic
 Hole: M9, Upper Hd.: 13MM,
 P.R.: 1.5MM, O/L: 17MM, Trim Thk.: 2MM
 Hyundai Accent, Santa Fe,
 Sonata, Tiburon & XG300/350 '99/
 Kia Optima, Rio & Sorento 2001/
 Chevrolet Aveo 2004/
 UNIT PACKAGE 25



99-8689

Replaces: 11561857
RETAINER-REAR BUMPER
MOULDING
 Plastic, 11x14MM
 Buick Lacrosse/Allure 2005/
 G.M. C/K Truck 2007
 UNIT PACKAGE 25

NEW ITEMS FOR FORD PRODUCTS

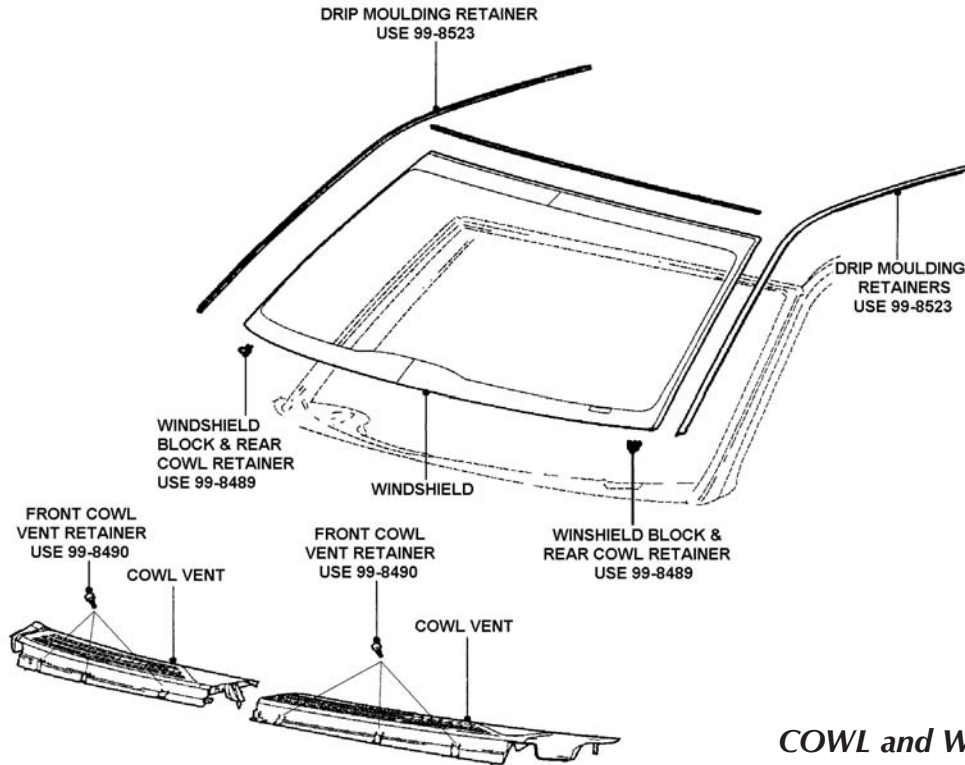

***COWL and WINDSHIELD
RETAINERS for
THE 'NEW' STYLE
FORD PICK-UPS 2004/***

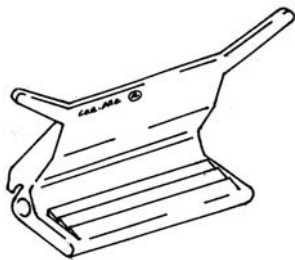

99-8523

Replaces: 4L3Z-1510182-AA
RETAINER-ROOF & GARNISH MOULDING
Plastic
Ford 'F' Pick-ups 2005
UNIT PACKAGE 15

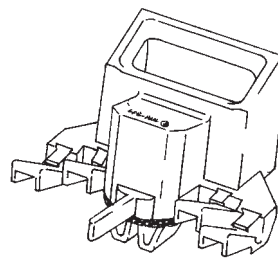

99-8489

Replaces: 4L3Z-1503296-AB,
BLOCK-WINDSHIELD SETTING
Plastic w/Seal
Ford Pick Up Truck '2004/
UNIT PACKAGE 5

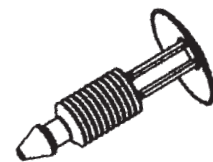

99-8490

Replaces: W710312-S300
RETAINER-COWL VENT
Plastic-Textured
Hole: M7.5 or M6.3x8.0MM Slot, Head:
18MM,
Stem Lgth.: 32MM, P.R.: 12-19MM
Ford Pick Up Trucks 2004
UNIT PACKAGE 25

NEW ITEMS FOR GENERAL MOTORS & FORD PRODUCTS

NEW ITEMS FOR FORD PRODUCTS

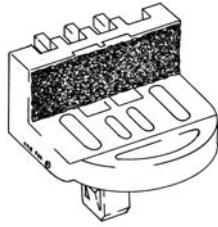

99-8591

Replaces: F6DZ-5403296-A
BLOCK-WINDSHIELD SETTING
 Plastic
 Ford Taurus & Sable 1996/
UNIT PACKAGE 10

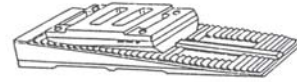

99-8633

Replaces: D8ZZ-69030A12-A,
 E9SZ-63030A12-A
BLOCK-WINDSHIELD SPACER
 Plastic, Adjustable
 Ford Various Cars & Lt. Duty Trucks '74-'98
UNIT PACKAGE 5



99-8551

Replaces: 10293193, N811040-S
RETAINER-HOOD INSULATOR,
 Door w/Strip
 Plastic
 Hole: M7, Head: 12.6MM,
 Stem Lgth: 15MM,
 P.R.: 0.8-8.0MM, O/L: 17.5MM
 Chevrolet Cobalt 2005, Ford Mustang 2005/
UNIT PACKAGE 50



99-8491

Replaces: W707504-S900
BLIND RIVET-MULTI GRIP STYLE
 Door Glass Moulding
 Rivet: 1/8"(M3.2), Flange 3/8" (9.5MM),
 G.R.: 0.157-0.312 (4.0-7.9MM)
 Aluminum Rivet w/Steel Mandrel
 Ford Freestar & Monterey 2004
UNIT PACKAGE 25

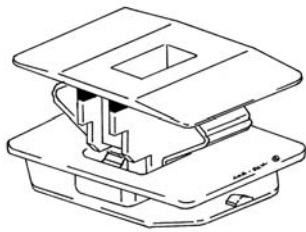

99-8645

Replaces: 6G1Z-5410182-A
RETAINER-LOWER ROCKER MOLDING
 Plastic
 Slot: 9x20MM, Upper Hd: 22x30MM,
 P.R.: 0.8MM
 Ford Five Hundred 2005/, Edge/MKX 2007/
UNIT PACKAGE 15



99-8647

Replaces: 6G1Z-5410182-C
RETAINER-WHEEL FLARE & ROCKER
 MOLDING
 Plastic
 Hole: M9, Flange: 14x18MM, P.R.: 0.8MM
 Ford Five Hundred 2005/
UNIT PACKAGE 25

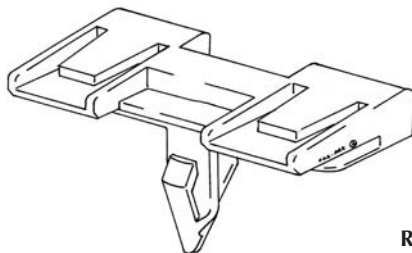

99-8646

Replaces: 6G1Z-5410182-B
RETAINER-UPPER ROCKER MOLDING
 Plastic
 Hole: M9
 Ford Five Hundred 2005/
UNIT PACKAGE 15

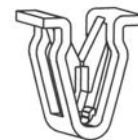

99-8648

Replaces: 6G1Z-5410182-D
RETAINER-ROCKER MOLDING
 Plastic
 Slot: 8.5x16MM
 Ford Five Hundred 2005/
UNIT PACKAGE 25

NEW ITEMS FOR FORD PRODUCTS

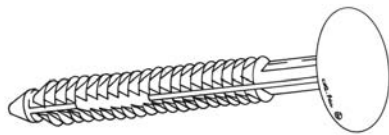

99-8606

Replaces: W710532-S300
RETAINER-ROCKER
 MOULDING
 Plastic
 Hole: M6.3, Head: 18MM,
 Stem Lgth: 43MM, P.R.: 10.5-37.5MM
 Ford Mustang 2005/
UNIT PACKAGE 25



99-8565

Replaces: 4001934, 7642589, W709883-S300
RETAINER-FIRE WALL INSULATOR, ROCKER MOLDING
 Plastic
 Formerly 72-3642
 Hole: M9.65, Head: 25.4mm, Stem Lgth: 36MM
 G.M. '68/ & Ford Mustang 2005/
UNIT PACKAGE 50



99-8582

Replaces: W707388-S300
RETAINER-FRONT BUMPER COVER
 Plastic-Black
 Hole 8x12MM, P.R.: 1.2-1.3MM
 Ford Escape 2001/
UNIT PACKAGE 10



99-8583

Replaces: W705849-S300
RETAINER-REAR BUMPER COVER
 Plastic-White w/Seal
 Hole 8x12MM, P.R.: 0.7-0.8
 Ford Escape 2001/
UNIT PACKAGE 10

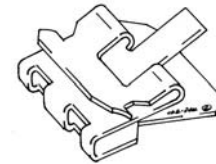

99-8703

Replaces: W701295-S301
CLIP-ENGINE SPLASH SHIELD
 Ford Focus 2000/
UNIT PACKAGE 10



99-8711

Replaces: W710250-S300
RIVET-SCREW TYPE, REAR BUMPER
 Plastic
 Hole: M8, Flange: 17.8MM,
 Stem Lgth: 18MM, P.R.: 3.8-5.0MM
 Ford Edge 2007/
UNIT PACKAGE 25

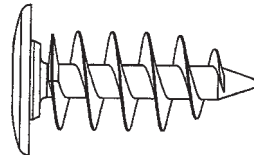

99-8656

Not Supplied by O.E.
SCREW-BUMPER & DOOR INSULATORS
 Plastic, Truss Head
 Hole: M12, Head: 22MM, O/L: 36MM,
 Thread Dia.: 14MM, Drive: #3 Square
 G.M., Ford & Chrysler 2005/
UNIT PACKAGE 25



99-8661

Replaces: 14083173, 17988488,
 17997722, 25536302, N803685-S
NUT-SNAP IN STYLE
 Front Bumper, Side/High Stop Lamps,
 Rear Wheel
 Flare & Interior Trim/Dash Mountings
 Screw: M4.2 (#8), Hole: 9x11MM
 G.M., Saturn, Hummer, Ford & Jeep '82/
UNIT PACKAGE 25



99-8649

Not Supplied by O.E.
RETAINER-WHEEL FLARE
 Plastic w/Seal
 Hole: M9
 Ford Explorer 2006/
UNIT PACKAGE 15



99-8604

Replaces: W711412-S300
GROMMET-REAR BUMPER
 Plastic
 Hole: M5.5-5.86sq.,
 Flange: 9.5MM sq.,
 O/L: 12.8MM, P.R.: 0.7-1.0MM,
 Screw: M4.2 (#8)
 Ford Fusion 2006
UNIT PACKAGE 50

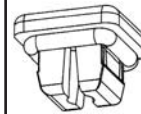

99-8605

Replaces: N811478-S100
GROMMET-LICENSE PLATE & REAR BUMPER
 Plastic w/Seal
 Hole: M9.5sq., Flange: 16MM,
 Leg Lgth: 8.3MM,
 P.R.: 0.8-3.4,
 Screw: M6.3 (1/4")
 Ford Mustang 2005/ &
 Fusion 2006
UNIT PACKAGE 15

NEW ITEMS FOR FORD PRODUCTS

NEW ITEMS FOR FORD & CHRYSLER PRODUCTS



99-8524

NOT SUPPLIED BY O.E.
RETAINER-WEATHERSTRIP
 Plastic
 Hole: M7, Head: 10MM,
 Stem Lgth.: 14.5MM,
 P.R.: 1-2.4MM
 Ford 'F' Series Pick Up 2004/
UNIT PACKAGE 100



99-8636

Not Supplied by O.E.
CLIP-WEATHERSTRIP
 Ford
UNIT PACKAGE 50

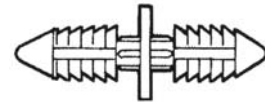

99-8546

Not Supplied by O.E.
RETAINER-GRILLE SHROUDS
 Plastic
 Hole: M6.35(1/4"), Flange: 12.7MM(1/2"),
 P.R.: 2.3-6.8MM Both ends
 Ford Explorer, Mountaineer
 & General Purpose
UNIT PACKAGE 25

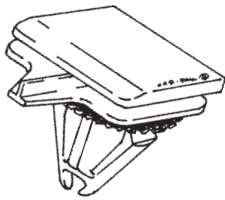

99-8545

Replaces: W710528-S300
RETAINER-SIDE MOULDING
 Plastic w/Seal
 Hole: M9, Top Head 14x20MM,
 O/L: 17MM, P.R.: 0.8MM
 Lincoln Navigator 2003/, Mustang 2005/
UNIT PACKAGE 15



99-8518

Replaces: 6507055AA, 6507686AA
RETAINER-DOOR PANEL
 Plastic
 Hole: M7, Upper Hd. Dia.:15MM,
 O/L: 23MM, Trim Thk: 2.36MM,
 P.R.: 1.7-3.0MM
 Jeep Gr. Cherokee 2003/
UNIT PACKAGE 50

CHRYSLER



99-8569

Replaces: 55157070AC
RETAINER-ROCKER MOULDING
 Plastic
 Hole: M7
 Jeep Liberty 2002/
UNIT PACKAGE 10

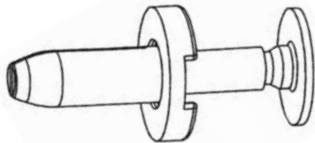

99-8658

Replaces: 5160260AA
RIVET-DRIVE TYPE, REAR BUMPER,
TAIL LAMP, FENDER, Plastic
 Hole: M8, Flange: 18MM,
 Stem Lgth: 20MM, P.R.: 2.6-3.0MM
 Dodge Caliber,
 Jeep Compass & Patriot 2007/
UNIT PACKAGE 15



99-8655

Replaces: 5159077AA
RETAINER-REAR BUMPER
 Plastic
 Jeep Gr. Cherokee 2005/
UNIT PACKAGE 25



99-8550

Replaces: 55157112AA, 55157112AB
RIVET-DRIVE TYPE, BUMPER COVER
 Plastic
 Hole: M9.75, Flange: 25.x45.MM,
 P.R.: 1.25MM, Shoulder: 2x10MM
 Jeep Gr. Cherokee 2005
UNIT PACKAGE 15

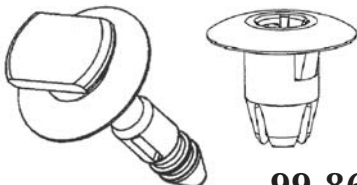

99-8662

Not Supplied By O.E.
RIVET-DRIVE TYPE, Sliding Side Door Motor
 Motor #4717974/5 AD AH, AI & 5166554AA
 Plastic, Contains: 25-Pins & 25-Grommets
 Hole: M12.5, Flange: 25MM,
 Pin Length: 36MM, Pin Head: 10x16MM
 Chrysler Mini Vans 2001/
UNIT PACKAGE 25

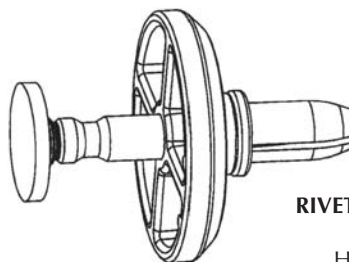

99-8657

Replaces: 4806334AA
RIVET-DRIVE TYPE, REAR BUMPER
 Plastic w/Seal
 Hole: M8.5, Flange: 34MM,
 Stem Lgth: 17MM,
 Shoulder: 3.5x11MM, P.R.: 0.5-1.5MM
 Dodge Caliber,
 Jeep Patriot & Compass 2007/
UNIT PACKAGE 10

NEW ITEMS FOR CHRYSLER PRODUCTS

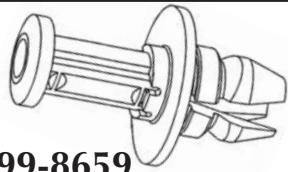

99-8659

Not Supplied by O.E.
RIVET-DRIVE TYPE,
REAR BUMPER MOUNTING BRACKET
 Plastic
 Hole: M10.5 Slot & M9.75 Hole,
 Flange: 22MM, Stem Lgth: 15MM
 Jeep Commander 2006/
UNIT PACKAGE 15

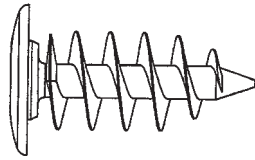

99-8656

Not Supplied by O.E.
SCREW-BUMPER & DOOR INSULATORS
 Plastic, Truss Head
 Hole: M12, Head: 22MM, O/L: 36MM,
 Thread Dia.: 14MM, Drive: #3 Square
 G.M., Ford & Chrysler 2005/
UNIT PACKAGE 25



99-8661

Replaces: 14083173, 17988488,
 17997722, 25536302, N803685-S
NUT-SNAP IN STYLE
 Front Bumper, Side/High Stop Lamps,
 Rear Wheel
 Flare & Interior Trim/Dash Mountings
 Screw: M4.2 (#8), Hole: 9x11MM
 G.M., Saturn, Hummer, Ford & Jeep '82/
UNIT PACKAGE 25



99-8566

Replaces: 55157055AA, 55157065AA
RETAINER-FENDER FLARES
 Plastic w/Seal
 Hole: M9, Top Head: 14x38MM,
 Stem Lgth: 15MM, P.R.: 0.75MM
 Jeep Liberty 2005
UNIT PACKAGE 15

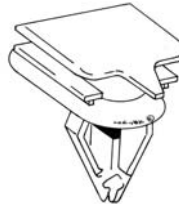

99-8650

Not Supplied by O.E.
RETAINER-FENDER & WHEEL FLARE
 Plastic
 Hole: M9, O/L: 20MM
 Jeep Commander 2006/
UNIT PACKAGE 25

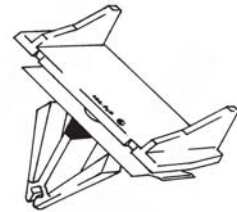

99-8568

Replaces: 55157069AB
RETAINER-ROCKER MOULDING
 Plastic
 Hole: M9
 Jeep Liberty 2002/
UNIT PACKAGE 25

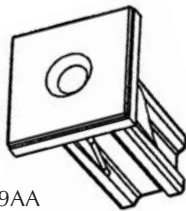

99-8567

Replaces: 6507009AA
GROMMET-DOOR & INTERIOR
TRIM PANELS
 Plastic w/Seal
 Hole: M9sq., Flange: 15MM,
 O/L: 21MM, P.R.: 0.66-2.0MM
 Dodge Durango, Jeep Liberty,
 Gr. Cherokee 2002/
UNIT PACKAGE 25



99-8516

Replaces: WX68DX9AA
RIVET- DOOR & INTERIOR TRIM PANELS
 Plastic - Textured
 Hole: M9, Flange: 22MM,
 Stem Lgth: 10MM,
 P.R.: 4.7MM
 Chrysler 300 & Dodge Magnum 2005
UNIT PACKAGE 25

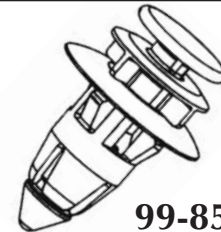

99-8562

Not Supplied by O.E.
RIVET-DRIVE TYPE, DOOR PANEL
 Plastic
 Hole: M13, Flange 25MM, O/L: 36MM,
 Upper Hd: 16MM, P.R.: 0.8-1.65MM
 Chrysler Pacifica 2004/
UNIT PACKAGE 25



99-8515

Not Supplied By O.E.
RETAINER-WEATHERSTRIP
 Plastic
 Hole: M6, Head: 5x15MM,
 O/L: 8.6MM, P.R.: 0.8-1.9MM
 Chrysler 300 & Dodge Magnum 2005
UNIT PACKAGE 100

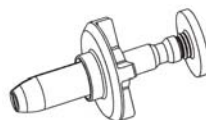

99-8512

Replaces: 4806110AA, 4389947AA
RIVET- FRONT & REAR BUMPERS
 Plastic
 Hole: M8.5, Flange: 24MM,
 Stem Lgth: 20.5MM,
 P.R.: 0.5-2.0MM, Shoulder: 3.5 x 11MM
 Chrysler 300, Sebring & Dodge Magnum
 2005/ & Dodge Journey 2009/
UNIT PACKAGE 15

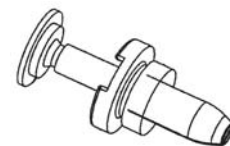

99-8513

Replaces: 4806240AA, 4806240AB
RIVET- REAR BUMPER
 Plastic
 Hole: M8, Flange: 18.5MM,
 Stem Lgth: 20.5MM,
 P.R.: 0.5-1.5MM, Shoulder: 1.8 x 11MM
 Chrysler 300 & Dodge Magnum 2005
UNIT PACKAGE 10

NEW ITEMS FOR FORD & CHRYSLER PRODUCTS

NEW ITEMS FOR CHRYSLER PRODUCTS & GENERAL PURPOSE



99-8514

Replaces: 1BA41AX1AA
RETAINER-ROCKER MOULDING
 Plastic-Textured
 Hole: 9x31MM Slot, Head: 12x20MM,
 Stem Lgth: 13.1MM
 Chrysler 300 & Dodge Magnum 2005
UNIT PACKAGE 15

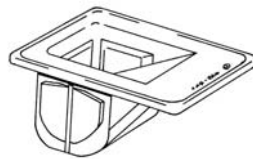

99-8623

Replaces: 55156879AB
GROMMET-TAIL LAMP
 Plastic
 Receives 10MM Ball Stud
 Jeep Commander 2006/
UNIT PACKAGE 25

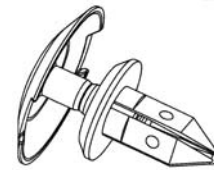

99-8624

Replaces: 55157330AC
RIVET-DRIVE TYPE, TAIL LAMP
 Plastic
 Hole: M8 sq., Flange: 20MM,
 Head: 31MM, Stem Length: 21MM,
 Shoulder: 10 x 3.5MM
 Jeep Commander 2006/
UNIT PACKAGE 15

WINDOW LIFT MOTOR

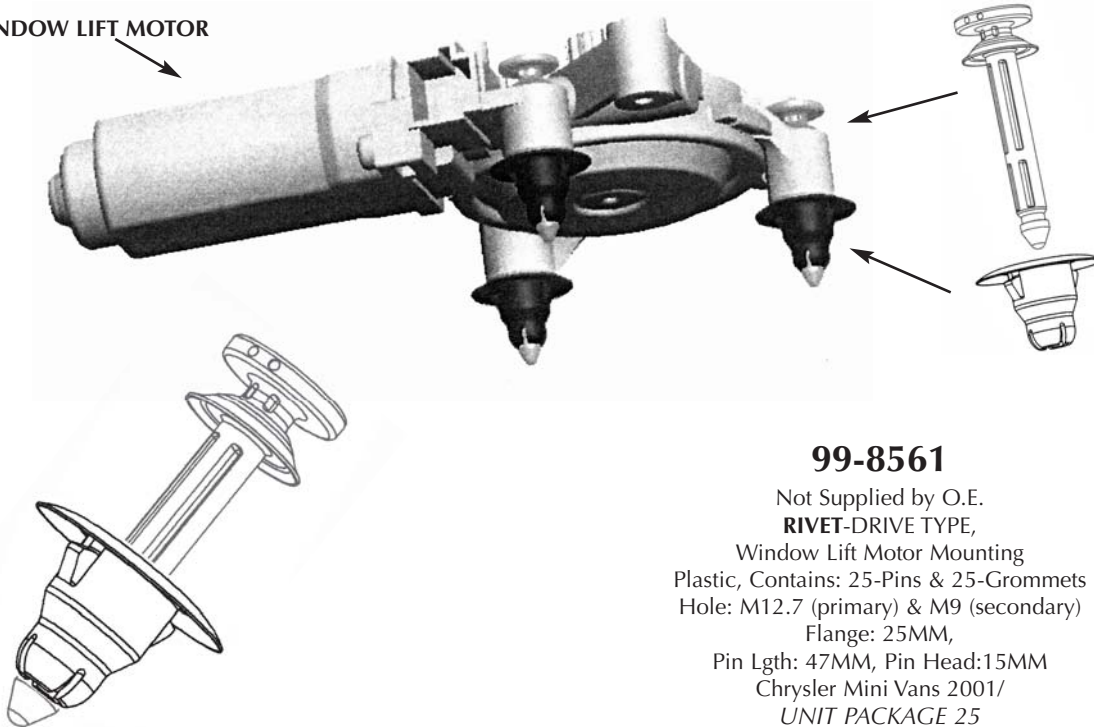

99-8561

Not Supplied by O.E.
RIVET-DRIVE TYPE,
 Window Lift Motor Mounting
 Plastic, Contains: 25-Pins & 25-Grommets
 Hole: M12.7 (primary) & M9 (secondary)
 Flange: 25MM,
 Pin Lgth: 47MM, Pin Head: 15MM
 Chrysler Mini Vans 2001/
UNIT PACKAGE 25

NEW GENERAL PURPOSE PRODUCTS

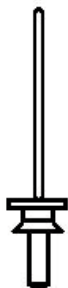
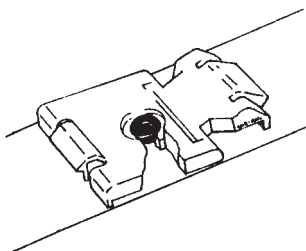

99-8549

Not Supplied By O.E.
BLIND RIVET-PIN TYPE w/TRIM
 CLIP STUD
 Aluminum Rivet & Mandrel
 Formerly 92-7069
 Rivet: 3/32 (2.4), Upper Flg.: 0.197 (5.0),
 Max G.R.: 0.098 (2.5)
 Replaces Weld-On Stud for
 Attaching Stud Style
 Moulding Clips to Panels
UNIT PACKAGE 25

NEW GENERAL PURPOSE PRODUCTS



99-8528

BLIND RIVET- CLOSED END
Sealing Type

Aluminum Rivet w/Aluminum Mandrel
M4.8 (.187) Rivet, Flange: 9.5MM (.375),
G.R.: 3.94-4.07(.154-.159),
Rivet Length: 11.6MM(.455)
General Purpose
UNIT PACKAGE 25



99-8626

BLIND RIVET-CLOSED END
SEALING TYPE

Aluminum Rivet, Steel Mandrel
3/16" (M5) Rivet, 3/8" (9.5MM) Flange,
0.126-0.248 (3.2-6.3MM) Grip Range
General Purpose
UNIT PACKAGE 50



99-8491

Replaces: W707504-S900
BLIND RIVET-MULTI GRIP STYLE
Door Glass Moulding
Rivet: 1/8"(M3.2), Flange 3/8" (9.5MM),
G.R.: 0.157-0.312 (4.0-7.9MM)
Aluminum Rivet w/Steel Mandrel
Ford Freestar & Monterey 2004
UNIT PACKAGE 25

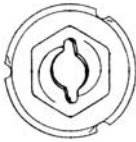

99-8672

NUT-THREAD CUTTING
w/Locking Tabs

Stud: 3/16", Washer: 5/8",
A/F: 3/8", Finish: Zinc
General Purpose
UNIT PACKAGE 100



99-8663

LOCK NUT-Stamped Hex
w/Faceted Washer

M6-1.0, Hex: 11MM, Flange Dia.: 18MM
Finish: Black
UNIT PACKAGE 50



99-8635

Not Supplied by O.E.
CLIP-GLASS RUN CHANNEL
Formerly SC-3142
Passenger Cars & Trucks
UNIT PACKAGE 25



99-8487

SCREW-INDENTED HEX HEAD
w/SEMS WASHER

M4.8-1.61x16MM, AB, Washer: 15MM,
A/F: 8MM Finish: Black
Imports & General Purpose
UNIT PACKAGE 100

99-8488

SCREW-INDENTED HEX HEAD
w/SEMS WASHER

M4.8-1.61x19MM, AB, Washer: 15MM,
A/F: 8MM Finish: Black
Imports & General Purpose
UNIT PACKAGE 100

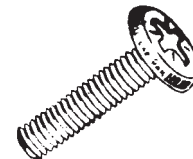

99-8526

SCREW-LICENSE PLATE
Phillips Pan Head

M6-1.0 x 16MM
Black Zinc Finish
General Usage & Imports
UNIT PACKAGE 100

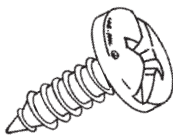

99-8560

Replaces: 25732397
SCREW-LICENSE PLATE
Phillips/Slotted Combo

Truss Head, AB Pointe
M6.3-1.81(1/4-14) x 20MM(25/32")
Finish: Silver Dacromet
G.M. 2002/ & General Purpose
UNIT PACKAGE 50



99-8732

Not Supplied by O.E.
SCREW-TAPPING, INDENTED HEX
WASHER HEAD

#10 x 3/4", Flange: 13/32", A/F: 5/16"
Finish: Black, (M4.8x19MM)
General Purpose
UNIT PACKAGE 100

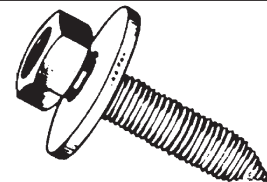

99-8731

Replaces: 25531999
BOLT-INDENTED HEX HEAD, w/SEMS
& Starter Point

M8-1.25 x 26MM, Washer: 24MM,
A/F: 13MM, Finish: Black
G.M. & General Purpose
UNIT PACKAGE 25

NEW ITEMS FOR CHRYSLER & GENERAL PURPOSE PRODUCTS

NEW METRIC & FRACTIONAL CAGED NUTS

METRIC



99-8708

NUT-CAGED
Thread: M5-0.8,
Panel Range: 2.4-3.2MM
Finish: Black Zinc
General Purpose
UNIT PACKAGE 50

METRIC



99-8709

NUT-CAGED
Thread: M6-1.0,
Panel Range: 2.4-3.2MM
Finish: Black Zinc
General Purpose
UNIT PACKAGE 50

METRIC



99-8710

NUT-CAGED
Thread: M8-1.25,
Panel Range: 1.6-2.4MM
Finish: Black Zinc
General Purpose
UNIT PACKAGE 50

NEW



99-8707

NUT-CAGED
Thread: 1/4-20",
Panel Range: 0.093-0.126
Finish: Black Zinc
General Purpose
UNIT PACKAGE 50

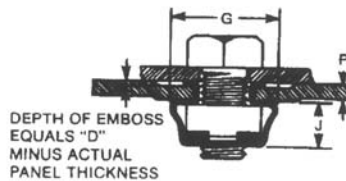

EXPANDED SELECTION OF CAGED NUTS INCLUDE METRICS

EXPANDED SELECTION OF CAGED NUTS INCLUDE METRICS

MOUNTING HOLE

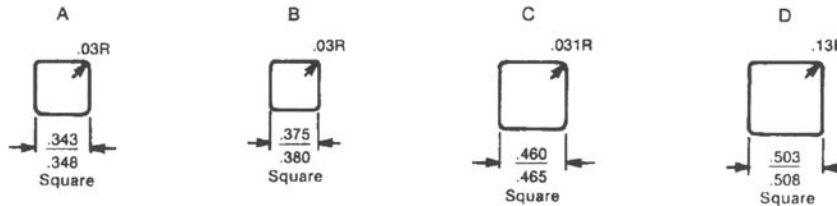

PART #	SCREW SIZE	P PANEL RANGE	MOUNT. HOLE	D	K	A	C	E	F	G	J	T	FINISH	UNIT PKG
J01011	10-24	.025-.063	A or B	0.100	0.156	0.520	0.340	0.060	0.290	0.540	0.250	0.020	BLACK	50
J01012	10-32	.025-.063	A or B	0.100	0.156	0.520	0.340	0.060	0.290	0.540	0.250	0.020	BLACK	50
J01013	1/4-20	.025-.063	A or B	0.100	0.187	0.520	0.340	0.060	0.290	0.540	0.250	0.020	BLACK	50
99-8707	1/4-20	.093-.126	A or B	0.130	0.180	0.520	0.380	0.070	0.275	0.540	0.250	0.016	BLACK	50
J01015	5/16-18	.028-.056	C or D	0.095	0.218	0.660	0.380	0.100	0.380	0.700	0.300	0.025	BLACK	50
99-8213	5/16-18	.177-.197	C or D	0.245	0.218	0.660	0.530	0.100	0.380	0.734	0.300	0.025	ZINC	50
J03880	3/8-16	.093-.126	C or D	0.175	0.218	0.660	0.460	0.100	0.440	0.700	0.300	0.025	BLACK	50
J01757	3/8-24	.093-.126	C or D	0.135	0.218	0.660	0.420	0.100	0.440	0.734	0.300	0.025	BLACK	50
99-8708	M5-0.8	2.4-3.2	A or B	3.2	4.5	13.2	9.9	1.9	7.0	13.0	6.3	0.45	BLACK	50
99-8709	M6-1.0	2.4-3.2	A or B	3.2	4.5	13.2	9.9	1.9	7.0	13.0	6.3	0.45	BLACK	50
99-8710	M8-1.25	1.6-2.4	C or D	2.4	5.6	15.8	10.5	2.8	10.7	16.0	7.8	0.60	BLACK	50

NEW ITEMS FOR GENERAL PURPOSE

PAINTLESS DENT REPAIR HOLE PLUGS



99-8584

HOLE PLUG
Plastic-Black

Hole: 1/8, Head: 13/64,
P.R.: 0.031-0.094

Use for Paint-less Dent Repair
& General Use
UNIT PACKAGE 100

99-8585

HOLE PLUG
Plastic-Black

Hole: 3/16, Head: 11/32,
P.R.: 0.031-0.140

Use for Paint-less Dent Repair
& General Use
UNIT PACKAGE 100

ADDITIONAL HOLE PLUGS FOR DENT REPAIR

Plastic (Black)
General Purpose

CAR-PAK NO.	HOLE SIZE	PANEL RANGE	UNIT PKG.
84-5872	3/8"	0.060-0.125	100
95-7448	1/2"	0.060-0.090	100
95-7449	5/8"	0.060-0.100	100
95-7450	11/16"	0.060-0.094	100
95-7451	3/4"	0.060-0.090	100
95-7452	7/8"	0.060-0.090	100
92-7064	1"	0.060-0.094	50

PLASTIC HOLE PLUGS RECESSED STYLE
FOR 14 TO 16 GAGE MATERIAL

CAR-PAK NO.	HOLE SIZE	UNIT PKG.
76-4379	1/2"	100
92-7063	3/4"	50
J06624	7/8"	100
J06625	1"	100
J06626	1-1/4"	50
J06627	1-1/2"	50
79-5015	1-5/8"	50
J06628	2"	50

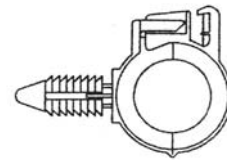

99-8527

Replaces: 12160374
CLIP- CONVOLUTED CONDUIT
Plastic
For 19MM(.750") Conduit
Hole M6.35(1/4"). P.R.: 12.5MM(1/2")
G.M. & General Purpose
UNIT PACKAGE 25

NEW ITEMS FOR IMPORT PRODUCTS

BMW

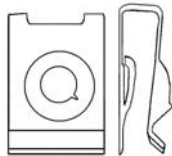

99-8637

Replaces: 07129-925-734, 07129-901-656
U-NUT - TAPPING
M4.8 (#10), 12.5x20MM,
P.R.: 2.5-3.5, Finish: Zinc
BMW 3, 7, 8 & Z3 '91/
UNIT PACKAGE 50

MERCEDES

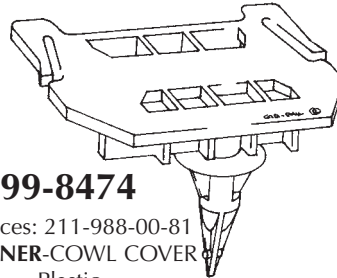

99-8474

Replaces: 211-988-00-81
RETAINER-COWL COVER
Plastic
Hole: M9
Mercedes E, CL & S Class 2000/
UNIT PACKAGE 10

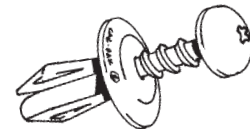

99-8520

Replaces: 123-990-05-92, 126-990-03-92
RIVET-COWL COVER
Plastic
Hole: M6.3, Flange: 16MM,
Stem Lgth: 11MM, P.R.: 5MM
Mercedes E, CL & S Class 2000/
UNIT PACKAGE 15

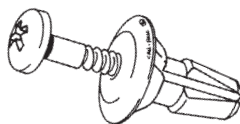

99-8684

Replaces: 51218-205-295
RIVET-SCREW TYPE
Cowl Vent
Formerly 99-8188
Plastic Use with 99-8189
BMW 5 '97-2003
UNIT PACKAGE 25

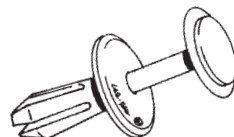

99-8521

Replaces: 001-990-13-92
RIVET-BACKGLASS MOULDING
Plastic
Hole: M5, Flange: 15MM,
Stem Lgth: 11MM, P.R.: 3-6MM
Mercedes C & SL Class 2001/
UNIT PACKAGE 15

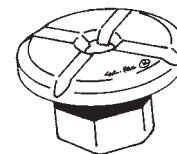

99-8511

Replaces: 201-990-00-50
NUT-FRONT FENDER APRON
Plastic, Self Threading
M4.8, Flange: 24MM, A/F: 10MM
Mercedes C, CLK & E CLASS '98/
UNIT PACKAGE 25

NEW ITEMS FOR GENERAL PURPOSE & IMPORT PRODUCTS

NEW ITEMS FOR IMPORT PRODUCTS

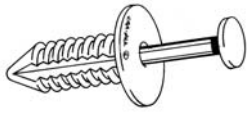

99-8660

Replaces: 124-990-04-92
RIVET-DRIVE TYPE, FENDER & GRILLE
 Plastic
 Hole: M7
 Mercedes C, CLK, CLS,
 E, M & R Class 2001/
UNIT PACKAGE 15

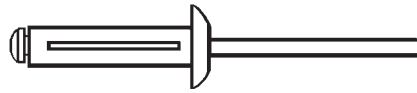

99-8682

Replaces: 003-990-94-97
BLIND RIVET-LEG RETENTION STYLE
 Bumpers
 Aluminum Rivet/Aluminum Mandrel
 5/32 (M4) Rivet, Flange: 5/16 (8MM),
 G.R.: .040-.275 (1.0-7.5MM)
 Mercedes & General Purpose
UNIT PACKAGE 25

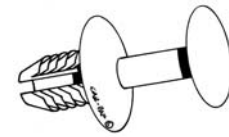

99-8693

Replaces: 230-990-01-92
RIVET-DRIVE TYPE, HOOD INSULATOR
 Plastic
 Hole: 8, Flange: 20MM,
 Stem Lgth: 9.5MM, P.R.: 5MM
 Mercedes GL, M, R, SL & SLK 2005/
UNIT PACKAGE 15



99-8460

Replaces: 007-988-34-78, 007-988-99-78
RETAINER-FRONT & REAR DOOR PANEL
 Plastic w/Seal
 Hole: M8, Upper Hd: 13MM, O/L: 19MM,
 Trim Thk: 2.3MM, P.R.: 1MM
 Mercedes '96/
UNIT PACKAGE 10



99-8547

Replaces: 003-988-41-78
RETAINER-INTERIOR TRIM
 Plastic
 Hole: M7.5, Head: 13MM, O/L: 16MM,
 Stem Lgth: 11MM, P.R.: 0.88MM
 Mercedes '66-'95
UNIT PACKAGE 15



99-8641

Replaces: 000-990-57-92
RETAINER-DECK LID PANEL
 Plastic
 Hole: M8, Head: 13MM,
 O/L: 16MM, Trim Thk: 1.5MM
 Mercedes S, SL, CL & E Class '86-2005
UNIT PACKAGE 15



99-8548

Replaces: 000-990-37-92
RIVET-INTERIOR TRIM
 Plastic
 Hole: M8-8.6, Flange: 8MM,
 Stem Lgth: 15MM, P.R.: 5.5-10MM
 Mercedes '99/
UNIT PACKAGE 15



99-8642

Replaces: 123-990-00-92
RIVET-DRIVE TYPE, RADIATOR SHROUD
 Plastic
 Hole: M8.5, Pin Head/Flange: 12MM,
 Stem Lgth: 10MM, P.R.: 4MM
 Mercedes CL, E & S Class '96/
UNIT PACKAGE 10

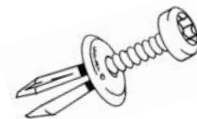

99-8638

Replaces: 000-990-40-92,
 124-990-05-92-9051
RIVET-SCREW TYPE, ENGINE COVER &
INTERIOR TRIM
 Plastic
 Hole: M5, Flange: 12MM,
 Stem Lgth: 11MM, P.R.: 6MM
 Mercedes 190D/E, E & CLK Class '84-2005
UNIT PACKAGE 15



99-8639

Replaces: 000-990-44-92
RIVET-SCREW TYPE,
 Plastic
 Hole: M5, Shoulder: 6X2.7MM
 Flange: 12MM,
 Stem Lgth: 11MM, P.R.: 8MM
 Mercedes 56, 380, 460 & 500 Class
UNIT PACKAGE 15

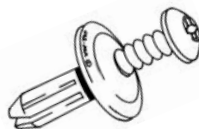

99-8640

Replaces: 000-990-46-92
RIVET-SCREW TYPE, ROCKER MOLDING
 Plastic
 Hole: M6.3, Flange: 17MM,
 Stem Lgth: 15MM, P.R.: 9.5MM
 Mercedes C & CLK Class '94-2003
UNIT PACKAGE 5



99-8643

Replaces: 000-997-91-86
PLUG
 Plastic
 Hole: M6, O/L: 13.5MM, P.R.: 3.5MM
 Mercedes 420/550 SEL Class '80-'91
UNIT PACKAGE 10

NEW ITEMS FOR IMPORT PRODUCTS



99-8644

Replaces: 001-990-00-91
U-NUT – WELD TYPE
 M6-1.0, P.R.: .5-1.7MM,
 Throat Depth: 15MM,
 Finish: Yellow Zinc
 Mercedes 56, 380, 460, 500 &
 SL400/500 class & General Purpose
UNIT PACKAGE 5



99-8563

Replaces: N908-338-01
GROMMET-FENDER APRON
 Plastic
 Screw: M4, Hole: 7.4MM, Flange: 15MM,
 O/L: 13.6MM, P.R.: 1.0-3.0MM
 VW Cabrio, Golf, Jetta & Phaeton '99/
UNIT PACKAGE 15

VOLKSWAGEN



99-8564

Replaces: N908-214-01
GROMMET-BUMPER & FENDER APRON
 Plastic
 Screw: M4, Hole: 7.4MM, Flange: 15MM,
 O/L: 21.3MM, P.R.: 0.7-2.2MM
 VW Cabrio, Golf, Jetta & Phaeton '99/ &
 Audi A4/S4, A6/S6 '96/
UNIT PACKAGE 15



99-8510

Replaces: 357-827-998
GROMMET-FRT. & REAR DOOR PANEL
 Plastic
 Hole: M8 sq. Flange: 16MM,
 O/L: 21MM, P.R.: 1MM, Screw M4.8(#10)
 VW Golf, Jetta, Passat & Cabrio '93/
UNIT PACKAGE 15

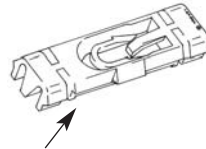

REPLACEMENT

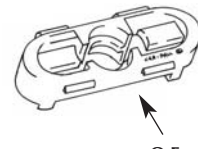

O.E.

99-8586

Replaces: 1H0-853-733B
RETAINER-ROOF DRIP MOLDING
 Plastic
 VW Golf, Jetta & Cabrio '93-'99
UNIT PACKAGE 25

VOLVO

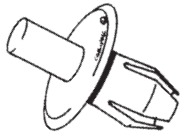

99-8162

Replaces: 9133417-7
RIVET-DRIVE TYPE
 Rocker Panel Molding
 Hole: M8, Flange: 16MM, PR: 8MM Max.
 Volvo Various Models '84/
UNIT PACKAGE 25

HYUNDAI/KIA



99-8472

Replaces: 81126-37010
RETAINER-HOOD INSULATION
 Plastic-Textured
 Hole: M9, Head: 26MM, O/L: 15.5MM
 Hyundai Elantra, Sonata, Tiburon '96/ & Kia
 XG300/350, Optima 2001
UNIT PACKAGE 25

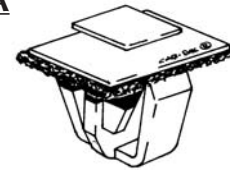

99-8475

Replaces: 87756-38000
RETAINER-ROCKER MOULDING
 Plastic, w/Seal
 Hole: 9.5x12MM, Flange 14x18MM,
 Upper Hd: 8x9MM, O/L: 15MM
 Hyundai Sonata '95/ & Kia Optima 2001
UNIT PACKAGE 15

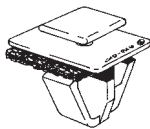

99-8476

Replaces: 87758-35000
RETAINER-ROCKER MOULDING
 Plastic, w/Seal
 Hole: 9.5x12MM, Flange 14x19MM,
 Upper Hd: 10x11MM, O/L: 14MM
 Hyundai Accent, Santa Fe
 & Tiburon '95/
UNIT PACKAGE 15

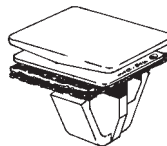

99-8477

Replaces: 87758-3D000
RETAINER-ROCKER MOULDING
 Plastic-Yellow, w/Seal
 Hole: M12 Slot,
 Upper Hd: 16x20MM,
 Trim Thk: 2.3MM
 Hyundai Sonata 2002/
UNIT PACKAGE 15

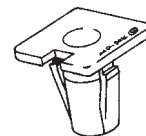

99-8505

Replaces: 87756-35000
GROMMET-ROCKER MOULDING
 Plastic
 Hole: 10MM, Flange: 13MM,
 O/L: 12MM, Screw: M5.48(#12)
 Hyundai Accent, Santa Fe,
 Sonata, Tiburon '95/
UNIT PACKAGE 25

NEW ITEMS FOR IMPORT PRODUCTS

NEW ITEMS FOR IMPORT PRODUCTS

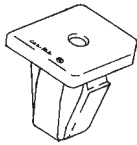

99-8507

Replaces: 87758-37000
GROMMET-FENDER & ROCKER MOUNTING
 Plastic w/Seal
 Hole: 8x10MM, Flange: 17MM Sq.,
 P.R.: 2MM, Screw: M4.2(#8)
 Hyundai Accent & Sonata '99/
 Kia Optima & Sorrento 2001/
UNIT PACKAGE 25



99-8504

Replaces: 86593-24000
RETAINER-BUMPER & GRILLE MOUNTING
 13.1 X 29.7MM
 Hyundai Accent, Santa Fe, Sonata '95/
UNIT PACKAGE 25



99-8473

Replaces: 86848-22000
GROMMET-FENDER APRON
 Plastic
 Hole: 8.5MM sq., Flange: 16MM,
 O/L: 12.5MM, Screw: M4.8 (#8)
 Hyundai Accent, Elantra, Sonata,
 Tiburon '95/
UNIT PACKAGE 25



99-8478

Replaces: 92351-37000
RETAINER-HEADLAMP ASSEMBLY
 Plastic
 Hole: 9.7MM, Flange: 14.5MM,
 O/L: 10MM
 Hyundai XG300/350 2001/ &
 Kia Rio, Spectra 2000/
UNIT PACKAGE 50



99-8503

Replaces: 82315-38000, 94530565
RETAINER-DOOR & INTERIOR TRIM PANEL
 Plastic
 Hole: M9, Upper Hd.: 13MM,
 P.R.: 1.5MM, O/L: 17MM, Trim Thk.: 2MM
 Hyundai Accent, Santa Fe,
 Sonata, Tiburon & XG300/350 '99/
 Kia Optima, Rio & Sorento 2001/
 Chevrolet Aveo 2004/
UNIT PACKAGE 25



99-8525

Replaces: 91518-S10-003
RETAINER-HOOD SEAL
 Plastic
 Hole: M5, Head: 11MM,
 P.R.: 3.5MM, O/L: 9.5MM
 Honda Accord & Odyssey '99/
UNIT PACKAGE 25



99-8706

Replaces: 90602-SLJ-003, 90603-SLJ-003
RETAINER-COWL VENT
 Plastic
 Slot: 7MM wide, Head: 10x14MM, O/L:
 18.5MM, P.R.: 2MM, Trim Thk.: 2.8MM
 Acura RDX & Honda CR-V 2007/
UNIT PACKAGE 10

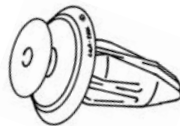

99-8687

Replaces: 90602-SAA-003
RETAINER-COWL VENT
 Plastic
 Hole: M8.5, Upper Hd: 12MM,
 Trim Thk: 3MM, O/L: 20.5MM
 Honda Fit 2007
UNIT PACKAGE 15

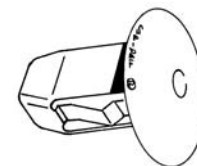

99-8617

Replaces: 90682-SEA-003
RETAINER-FENDER APRON
 Plastic
 Hole: 9MM Sq., Flange: 20MM,
 O/L: 14MM, P.R.: 3.5MM
 Honda Civic & Odyssey 2005/
 Acura TSX 2004/
UNIT PACKAGE 25



99-8618

Replaces: 91501-SEA-003
RETAINER-FENDER GARNISH MOLDING
 Plastic
 Hole: M6, Flange: 20MM,
 Stem Lgth: 16MM, P.R.: 9MM
 Honda Civic 2006
UNIT PACKAGE 15

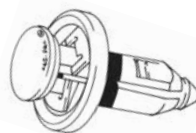

99-8619

Replaces: 91505-S9A-003
RIVET-DRIVE TYPE, FRONT BUMPER
 Plastic w/Metal Insert
 Hole: M10, Flange: 20MM,
 Stem Lgth: 13MM, P.R.: 6MM
 Honda Civic 2006 & Fit 2007
UNIT PACKAGE 10

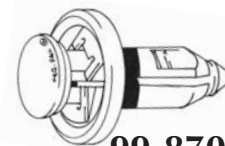

99-8705

Replaces: 91506-S9A-003
DRIVE RIVET-BUMPER, UPPER & LOWER ENGINE COVER
 Plastic w/Metal Insert
 Hole: M10, Flange: 20MM,
 Stem Lgth: 16MM, P.R.: 8MM
 Acura MDX, RDX, TSX 2004/
 Honda Civic & CR-V 2006/
UNIT PACKAGE 10

NEW ITEMS FOR IMPORT PRODUCTS

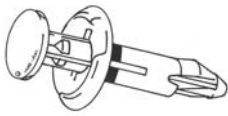

99-8681

Replaces: 90505-SX0-003
RIVET-DRIVE TYPE, SIDE MOLDING
 Plastic-Matte & Textured
 Hole: M8, Flange: 18MM,
 Stem Lgth.: 15MM, P.R.: 9-11MM
 Honda CR-v & Odyssey '95/
UNIT PACKAGE 10



99-8628

Replaces: 75305-S0A-003
RETAINER-SIDE MOULDING
 Plastic-White
 Acura TL & RL '96-2004
 Honda Civic, CR-V, Odyssey & Pilot '97/
UNIT PACKAGE 15

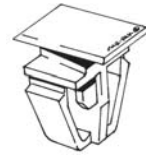

99-8629

Replaces: 75305-SH2-003
RETAINER-SIDE MOLDING
 Plastic-Blue
 Acura CL, TL RL & Legend '91/
 Honda Civic & CR-V '92/
UNIT PACKAGE 15



99-8630

Replaces: 75305-SH4-003
RETAINER-SIDE MOLDING
 Plastic-Red
 Acura TL '95-'98
 Honda Civic & CR-V '96/
UNIT PACKAGE 15

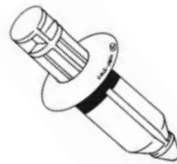

99-8601

Replaces: 91505-ST7-003ZA
RIVET-DRIVE TYPE, DOOR PANEL
 Plastic-Textured
 Hole: M8, Flange: 17MM,
 Stem Lgth: 12MM, P.R.: 3-8MM
 Honda CR-V & S2000 2000/
UNIT PACKAGE 10

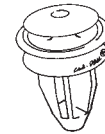

99-8602

Replaces: 91560-S9A-A01
RETAINER-DOOR PANEL
 Plastic
 Hole: M9, Upper Hd: 13MM, P.R.: 1.5MM,
 O/L: 19MM, Trim Thk.: 2.5MM
 Honda Accord, Civic, CR-V &
 Odyssey 2002/
 Acura TL & TSX 2004/
UNIT PACKAGE 25

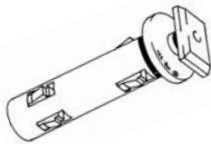

99-8599

Replaces: GJ6A-68-162
**RETAINER-WINDSHIELD GARNISH
 MOLDING**
 Plastic
 Hole: M10, Head: 10x13MM,
 O/L: 41MM, Trim Thk.: 3MM
 Mazda 3, 5 & RX8 2004/
UNIT PACKAGE 10

MAZDA

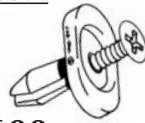

99-8600

Replaces: 3M8Z-1502316-A,
 GJ6E-50-715A
RIVET-SCREW TYPE, COWL VENT
 Plastic
 Hole: M5, Flange: 8.5x12MM,
 Stem Lgth: 8.7MM, P.R.: 5MM Max
 Ford Fusion, Milan & Zephyr 2006
 Mazda 5 & 6 2003/
UNIT PACKAGE 15

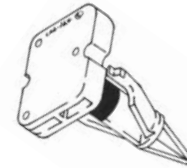

99-8616

Replaces: GM9E-63-938A
**RETAINER-UPPER WINDSHIELD
 MOLDING**
 Plastic
 Hole: M8, Flange: 17x20MM,
 O/L: 25MM
 Mazda 6 2003/
UNIT PACKAGE 10



99-8500

Replaces: G043-50-742
**RETAINER-FENDER APRON
 & EXTERIOR TRIM PANELS**
 Plastic w/Seal
 Hole: M8.5, Upper Hd: 14MM,
 O/L: 18MM, P.R.: 1.5MM,
 Trim Thk: 2.5MM
 Mazda Various Models '92/
UNIT PACKAGE 15

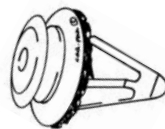

99-8692

Replaces: G18K-51-SJ3
**RETAINER-FENDER & ROCKER
 MOULDING, Plastic, W/Seal**
 Hole: M10, Head Dia: 14MM,
 Trim Thk: 2.5MM, O/L: 19MM
 Mazda CX-9, 3, 5, 6 MPV,
 MX-5/Miata & Protege '99/
UNIT PACKAGE 10

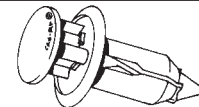

99-8519

Replaces: YL8Z-16K262-HC,
 GD7A-50-EA1
**RIVET-PIN DRIVE TYPE
 BUMPER COVER & GRILLE**
 Plastic
 Hole: M10, Flange: 19.5MM,
 Stem Lgth: 15MM, P.R.: 8.5MM
 Ford Mustang 2005/
 Mazda Cars & Trucks '99/
UNIT PACKAGE 10

NEW ITEMS FOR IMPORT PRODUCTS

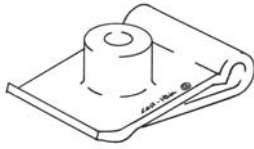

99-8597

Replaces: B455-56-135
U-NUT - FRONT BUMPER
 Plastic
 Screw: M4.8 (#10), Width: 20MM,
 Length: 22MM, Throat: 12MM
 Mazda Various Models '92/
UNIT PACKAGE 25

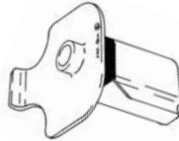

99-8598

Replaces: GJ6A-50-0Z5
GROMMET-FRONT BUMPER
 Plastic
 Hole: 8.5x12MM Oval,
 Flange: 23.5x24MM,
 Screw: M4.2 (#8)
 Mazda MPV,
 3, 5, 6 Miata & RX8 2000/
UNIT PACKAGE 15



99-8620

Replaces: BC1M-50-0Z5
GROMMET-FRONT BUMPER
 Plastic
 Hole: 7x12MM Oval,
 Flange: 24x28MM, Screw: M4.2 (#8)
 Mazda 323, Protégé, 626,
 Miata & MPV '95/
UNIT PACKAGE 10



99-8615

Replaces: GJ6R-68-ABX, GJ6A-68-AB1
RETAINER-DOOR PANEL
 Plastic- w/Seal
 Hole: M8.5, Upper Hd.: 13MM,
 O/L: 18MM,
 P.R.: 2MM, Trim Thk.: 1.8MM
 Mazda 3, 5, 6, Miata & RX-8 2003/
UNIT PACKAGE 15

NISSAN/INFINITY

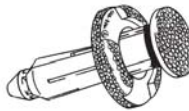

99-8494

Replaces: 11296-AG000
RIVET-DRIVE TYPE (Re-usable)
 Front Bumper & Radiator Support
 Plastic - Textured
 Hole: M8, Flange: 20MM,
 Stem Lgth: 13MM. P.R.: 2-6MM
 Nissan Altima, Maxima & Quest 2002/
 Infinity FX35/45 2003/
UNIT PACKAGE 25

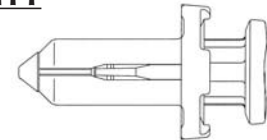

99-8554

Replaces: 63848-9E001
RIVET-DRIVE TYPE
 Bumper Cover
 Plastic
 Hole: M9, Flange: 18MM,
 O/L: 33.5MM, P.R.: 12MM Max.
 Nissan Altima & Xterra 1998/
UNIT PACKAGE 15



99-8492

Replaces: 01281-00331
GROMMET-BUMPER,
ROCKER PNL. & LAMP MTG.
 Plastic w/Seal
 Hole: M10sq., Flange: 20 MM,
 O/L: 17MM, P.R.: 3MM,
 Screw: M6.3 (#14)
 Nissan 240SX, Altima, Maxima,
 Pathfinder & Quest '96/
 Infinity G35, Q45 & QX4 '97/
UNIT PACKAGE 25



99-8493

Replaces: 01281-00831
GROMMET-BUMPER,
FENDER & LAMP MTG.
 Plastic
 Hole: M8.5sq., Flange: 16 MM,
 O/L: 11MM, P.R.: 1.5MM
 Screw M4.2 (#8)
 Nissan 240SX, Altima, Frontier,
 Maxima, Pathfinder, Quest & Xterra '89/
 Infinity G20, I30/35 & QX4 '91/
UNIT PACKAGE 25



99-8495

Replaces: 01553-01182
RETAINER-COWL & FENDER APRON
 Plastic-Textured
 Hole: M5, Head: 15MM,
 Stem Lgth: 14MM, P.R.: 2-9MM
 Nissan Altima, Frontier, Quest,
 Xterra & Pick Up '86/
UNIT PACKAGE 25

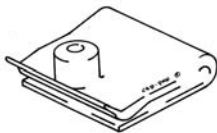

99-8685

Replaces: 76882-0M000
U-NUT-FENDER
 Plastic
 Screw: M4.8(#10), Width: 20MM,
 Length: 20.5MM, Throat: 8MM
 Nissan '95/ & Infinity '96/
UNIT PACKAGE 15

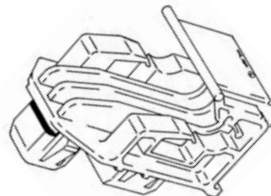

99-8686

Replaces: 26398-2Y001
RETAINER-HEADLAMP HOUSING
 Plastic
 Hole: 1-M9sq & 1-M10sq
 Nissan Sentra 2000-2006
UNIT PACKAGE 5



99-8574

Replaces: 90467-10188, 91560-S6A-003
RETAINER-COWL, W/S GARNISH,
INTERIOR TRIM, Plastic w/Seal
 Hole: M8.5, Upper head: 13MM,
 Trim Thk: 2.5MM, O/L: 20MM,
 P.R.: 0.7-1.4MM
 Toyota Cars & Trucks '98-2004
 Acura 2005/ & Honda 2004/
UNIT PACKAGE 25

NEW ITEMS FOR IMPORT PRODUCTS

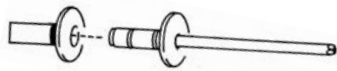

99-8610

Replaces: 90269-04051, 90269-A0006
BLIND RIVET-WINDOW DOOR MOLDING
 Hole: M4 (5/32"), Rivet: M3.2 (1/8"),
 Flange: 6MM (15/64"),
 G.R.: 1.2-3.4MM (0.047-0.134),
 Rivet Lgth: 7.1MM (9/32")
 Aluminum Rivet w/ Steel Mandrel
 & Plastic Seal
 Lexus ES, IS Models '98/Toyota Camry 2007
UNIT PACKAGE 15

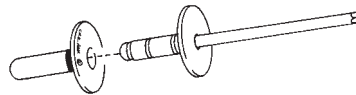

99-8611

Replaces: 90269-04006
BLIND RIVET-DOOR BODY MOLDING
 Hole: M4 (5/32"), Rivet: M3.2 (1/8"),
 Flange: 8.0MM (5/16"),
 G.R.: 1.2-4.0MM (0.047-0.157),
 Rivet Lgth: 9.0MM (23/64")
 Aluminum Rivet w/ Steel Mandrel
 & Plastic Seal
 Lexus GS Models '98/
UNIT PACKAGE 15



99-8575

Replaces: 90467-A0008
RETAINER-BUMPER COVERS
 Plastic
 Hole: M6.35, Head: 19MM,
 Stem Lgth:16MM, P.R.: 2.7-7.3MM
 Toyota, Lexus & Scion '95/
UNIT PACKAGE 50

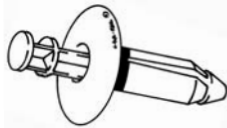

99-8680

Replaces: 90467-08180
RIVET- DRIVE TYPE, BUMPER & ROCKER PANEL
 Plastic, Textured
 Hole: M8, Flange: 17MM,
 Stem Lgth: 12MM, P.R.: 7MM
 Toyota Camry 2007
 Lexus RX335/350/400h 2004/
UNIT PACKAGE 15

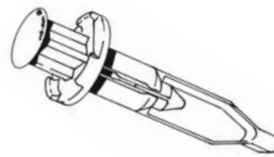

99-8576

Replaces: 52161-20010
RIVET-DRIVE TYPE BUMPER COVERS & GRILLE
 Plastic
 Hole: M9, Flange: 18MM,
 Stem Lgth: 31MM, P.R.: 3.5-10MM
 Toyota & Scion 2000/
UNIT PACKAGE 15



99-8677

Replaces: 52535-50060, 52535-0E010
GROMMET-FRONT BUMPER
 Plastic
 Hole: 9x12MM, Screw: M5.48 or M6.0
 Toyota Camry, Highlander
 & Tacoma 2001/
 Lexus RX330/350/400h,
 LS430 & IS250/350 2001/
UNIT PACKAGE 5

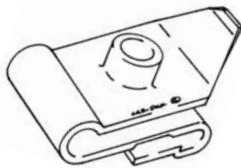

99-8577

Replaces: 90467-05114
U-NUT-BUMPER & FENDER APRON
 Plastic
 Screw: M5.48 (#12)
 Toyota & Lexus 2000/
UNIT PACKAGE 10

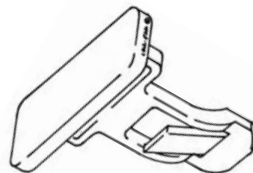

99-8679

Replaces: 75392-35200, 75392-04010
RETAINER-FENDER FLARE & BUMPER
 Plastic - Blue
 Toyota Camry, FJ,
 Rav4 & Tacoma 2005/
UNIT PACKAGE 15

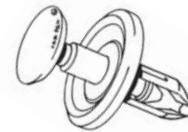

99-8587

Replaces: 90467-07201
RIVET-DRIVE TYPE, Engine Under Cover
 Plastic
 Hole: M7, Flange: 20MM,
 Stem Lgth: 10MM, P.R.: 2.2-6.5MM
 Toyota Avalon, Camry, Solara 2002/
 & Lexus ES300/330 2002/
UNIT PACKAGE 10

99-8501

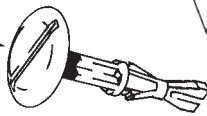

99-8501

Replaces: 47749-58010
PIN-FRONT FENDER
 Plastic, Use w/99-8502
 Head: 15.5MM, Stem Lgth: 25MM
 Toyota Solara, Highlander,
 Sienna & 4Runner 2000/
 Lexus GX470 2003/
UNIT PACKAGE 10

99-8502

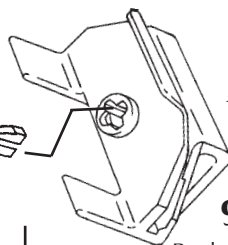

99-8502

Replaces: 53879-58010
CLIP-FRONT FENDER
 Plastic, Use w/99-8501
 Toyota Solara, Highlander,
 Sienna & 4Runner 2000/
 Lexus GX470 2003/
UNIT PACKAGE 5

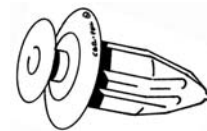

99-8678

Replaces: 75867-AA010
RETAINER-ROCKER PANEL & SCUFF PLATE, Plastic
 Hole: M8, Head: 13MM,
 Trim Thk: 2.5MM, O/L: 18MM
 Toyota Avalon, Camry, Solara 2004/
 Scion xA 2004/
 Lexus ES300/330 2002/
UNIT PACKAGE 15

NEW ITEMS FOR IMPORT PRODUCTS

NEW ITEMS FOR IMPORT PRODUCTS

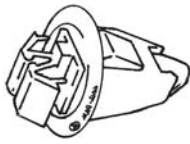

99-8556

Replaces: 75396-35020, 75495-35010

RETAINER-FENDER FLARE & SIDE MOULDING

Plastic-Blue

Hole: M9sq., Flange: 17MM, O/L: 17MM
Toyota 4Runner, Tacoma 2003/ & Lexus GX470 2003-2004
UNIT PACKAGE 15



99-8555

Replaces: 75395-35070, 75397-35010

RETAINER-FENDER FLARE & SIDE MOULDING

Plastic-Orange

Hole: M9sq., Flange: 17MM, O/L: 22.5MM
Toyota 4Runner, Tacoma 2003/ & Lexus GX470 2003-2004
UNIT PACKAGE 15



99-8517

Replaces: 53879-60010
RIVET- DRIVE TYPE, FENDER LINER

Plastic, Textured Head
Hole: M7, Flange: 18MM,
Stem Lgth: 6.5MM, P.R.: 3.5MM

Toyota Land Cruiser '98/, Rav4 2001/ & Lexus LX470 '98/
UNIT PACKAGE 10

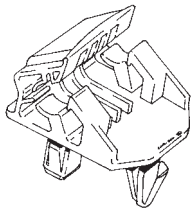

99-8529

Replaces: 53271-44010

RETAINER-HEADLAMP HOUSING MOUNTING

Plastic

Hole: 1-M9 & 1-M10 sq.
Toyota Camry & RAV4 2001/, Lexus IS300 2001/
UNIT PACKAGE 5

NEW "C" CHARTS

**'C' Tree
Fastener
Charts
Part No.
X-CT-CH**

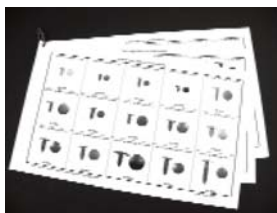

**** Car-Pak's 'NEW' 'C' Tree fastener identification charts are now available. Easy to 'C' & Easy to 'ID' 'C' the Size by Comparison 'C' the Type 'C' Charts!**

**** This 6 page chart has 88 Popular Tree fasteners sorted by head style, hole diameter and stem length.**

**** All fasteners have actual size photos in both top and side view for easy identification.**

**** The charts sized at 8-1/2 x 14" printed both sides make it easy to transport and will not take up valuable wall space in the shop.**

**** The charts are packaged 3 sets per unit.**

The 'C' charts will prove to be a great tool for both salesman and your customers.

NEW "C" CHARTS

'C' Trim Fastener Charts Part No. X-NT-CH

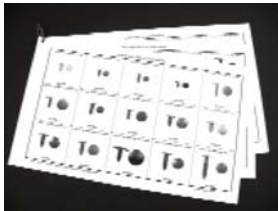

**** Car-Pak's 'NEW' 'C' Trim fastener identification charts are now available.**

**Easy to 'C' & Easy to 'ID'
'C' the Size by Comparison
'C' the Type
'C' Charts!**

**** This 6 page chart has 82 Popular Trim fasteners sorted by Head style, hole diameter and stem length.**

**** All fasteners have actual size photos in both top and side view for easy identification.**

**** The charts sized at 8-1/2 x 14" printed both sides make it easy to transport and will not take up valuable wall space in the shop.**

**** The charts are packaged 3 sets per unit.**

The 'C' charts will prove to be a great tool for both salesman and your customers.

'C' Rivet Fastener Charts Part No. X-RV-CH



**** Car-Pak's 'NEW' 'C' Rivet fastener identification charts are now available.**

**Easy to 'C' & Easy to 'ID'
'C' the Size by Comparison
'C' the Type
'C' Charts!**

**** This 6 page chart has 90 Popular Rivet fasteners sorted by Drive style, hole diameter and stem length.**

**** All fasteners have actual size photos in both top and side view for easy identification.**

**** The charts sized at 8-1/2 x 14" printed both sides make it easy to transport and will not take up valuable wall space in the shop.**

**** The charts are packaged 3 sets per unit.**

The 'C' charts will prove to be a great tool for both salesman and your customers.

NEW ITEMS FOR GENERAL MOTORS PRODUCTS

DOOR HINGE REPAIR KIT for G.M. ENVOY, RAINIER & TRAILBLAZER 2002/

*ECONOMICALLY
REPAIR WORN OUT
DOOR HINGE PINS
ON VEHICLES WITH
WELDED HINGES
WITHOUT REMOVING
THE HINGE.*

**USING CAR-PAK'S
99-8631 REPAIR KIT**

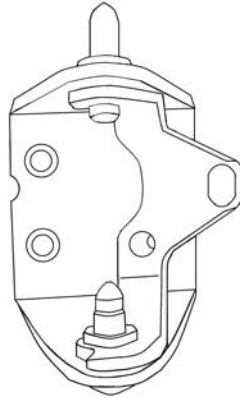

99-8631

Not Supplied by O.E.
KIT-DOOR HINGE REPAIR

- Contents:
2-Pins
2-Bushings
2-Lock Washers
2-Lock Nuts

G.M. Envoy, Rainier, Trailblazer 2002/
UNIT PACKAGE 1

CASE HARDENED
FORGED PINS WITH
DACROMET
(500 hr Salt Spray)
FINISH

BRONZE
BUSHINGS

THRU HARDENED
WASHERS

PREVAILING TORQ
LOCK NUTS

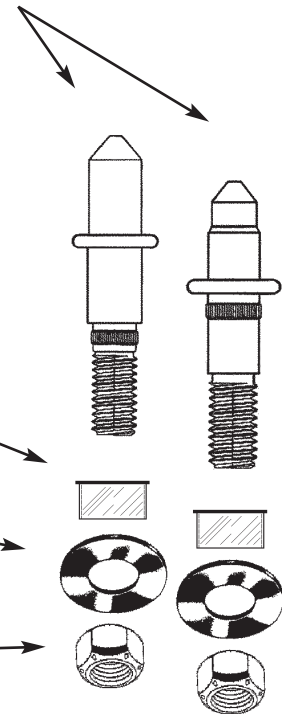

***DOOR HINGE REPAIR KIT for G.M. C/K TRUCKS & FULL SIZE SUV '99 & UP
PREVIOUSLY ANNOUNCED***

*ECONOMICALLY
REPAIR WORN OUT
DOOR HINGE PINS
ON VEHICLES WITH
WELDED HINGES
WITHOUT REMOVING
THE HINGE.*

**USING CAR-PAK'S
99-8393 REPAIR KIT**

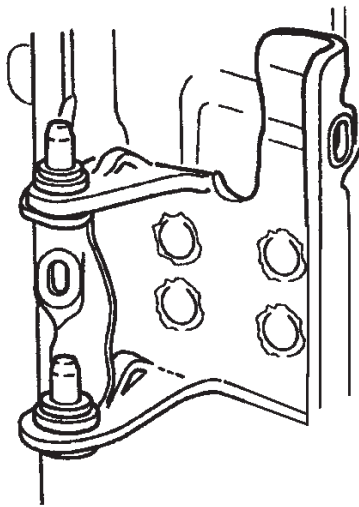

99-8393

Not Supplied By O.E.
KIT- DOOR HINGE PIN REPAIR

- Contents:
2-Pins
2- Bushings
2-Lock Washers
2-Lock Nuts

G.M. C/K Trucks & Full Size SUV's '99/
UNIT PACKAGE 1

CASE HARDENED
FORGED PINS WITH
DACROMET
(500 hr Salt Spray)
FINISH

**'NO HINGE
REMOVAL
NEEDED'**

BRONZE
BUSHINGS

THRU HARDENED
WASHERS

PREVAILING TORQ
LOCK NUTS

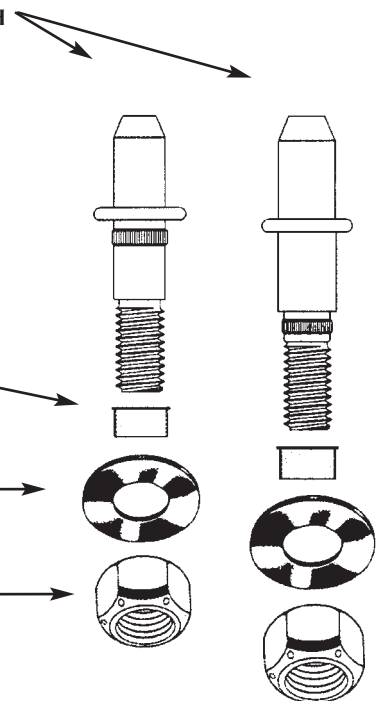

NEW ITEMS FOR GENERAL MOTORS PRODUCTS

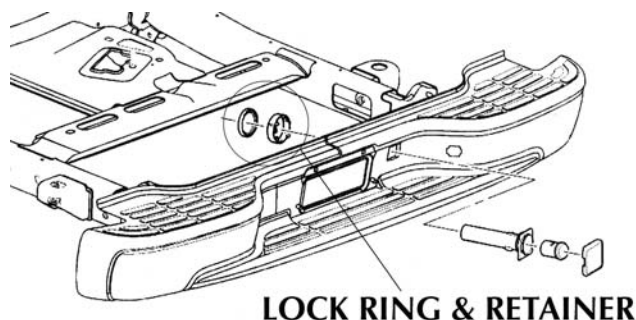

LOCK RING & RETAINER

RETAINER & LOCK RING for SPARE TIRE LOCK CYLINDER HOUSING FULL SIZE 'C/K' G.M. TRUCKS & SUV's. '99/

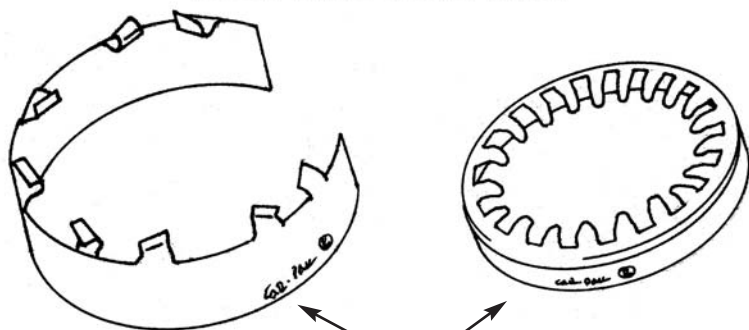

99-8570 KIT

99-8570

Replaces: 15040331 & 15769308
RETAINER & LOCK RING-SPARE TIRE
LOCK CYLINDER

Damaged whenever the bumper is removed.
G.M. C/K Trucks. Sierra, Silverado,
Denali, Escalade,
Tahoe, Yukon & Suburban's '99/
UNIT PACKAGE 5

NEW ITEMS FOR WEATHER PACK CONNECTORS & SEALS

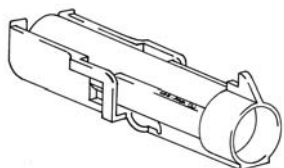

99-8714

Replaces: 12010996
CONNECTOR-WEATHERPACK
1 WAY SHROUD
(connector & seal)
Mates w/99-8715 Tower
UNIT PACKAGE 10

1 WAY

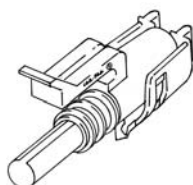

99-8715

Replaces: 12015791
CONNECTOR-WEATHERPACK
1 WAY TOWER
(connector & seal)
Mates w/99-8714 Shroud
UNIT PACKAGE 10

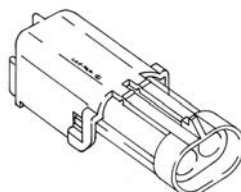

99-8716

Replaces: 12010973
CONNECTOR-WEATHERPACK
2 WAY SHROUD
(connector & seal)
Mates w/99-8717 Tower
UNIT PACKAGE 10

2 WAY

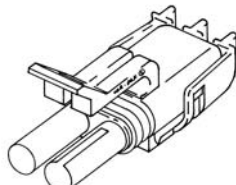

99-8717

Replaces: 12015792
CONNECTOR-WEATHERPACK
2WAY TOWER
(connector & seal)
Mates w/99-8716 Shroud
UNIT PACKAGE 10

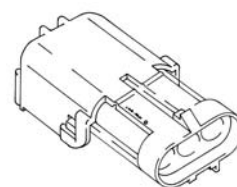

99-8718

Replaces: 12010717
CONNECTOR-WEATHERPACK
3 WAY SHROUD
(connector & seal)
Mates w/99-8719 Tower
UNIT PACKAGE 10

3 WAY

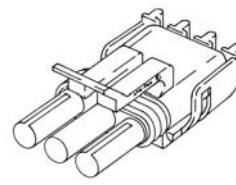

99-8719

Replaces: 12015793
CONNECTOR-WEATHERPACK
3 WAY TOWER
(connector & seal)
Mates w/99-8718 Shroud
UNIT PACKAGE 10

NEW ITEMS FOR WEATHER PACK CONNECTORS & SEALS

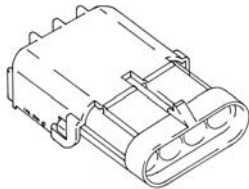

99-8720

Replaces: 12010974
CONNECTOR-WEATHERPACK
 4 WAY SHROUD
 (connector & seal)
Mates w/99-8721 Tower
UNIT PACKAGE 10
4 WAY

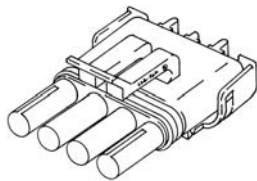

99-8721

Replaces: 12015797
CONNECTOR-WEATHERPACK
 4 WAY TOWER
 (connector & seal)
Mates w/99-8720 Shroud
UNIT PACKAGE 5

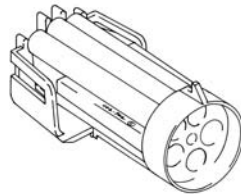

99-8722

Replaces: 12065158
CONNECTOR-WEATHERPACK
 5 WAY RD. SHROUD
 (connector & seal)
Mates w/99-8723 Tower
UNIT PACKAGE 5
5 WAY ROUND

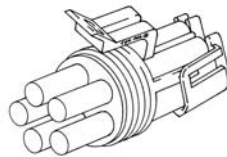

99-8723

Replaces: 12034342
CONNECTOR-WEATHERPACK
 5 WAY RD. TOWER
 (connector & seal)
Mates w/99-8722 Shroud
UNIT PACKAGE 2

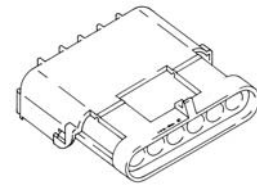

99-8724

Replaces: 12010975
CONNECTOR-WEATHERPACK
 6 WAY SHROUD
 (connector & seal)
Mates w/99-8725 Tower
UNIT PACKAGE 5
6 WAY

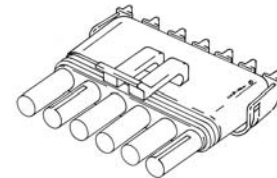

99-8725

Replaces: 12015799
CONNECTOR-WEATHERPACK
 6 WAY TOWER
 (connector & seal)
Mates w/99-8724 Shroud
UNIT PACKAGE 5

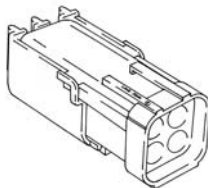

99-8726

Replaces: 12015024
CONNECTOR-WEATHERPACK
 4 WAY SQ. SHROUD
 (connector & seal)
Mates w/99-8727 Tower
UNIT PACKAGE 10
4 WAY SQUARE

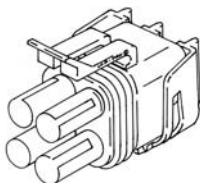

99-8727

Replaces: 12015798
CONNECTOR-WEATHERPACK
 4 WAY SQ. TOWER
 (connector & seal)
Mates w/99-8726 Shroud
UNIT PACKAGE 5



99-8728

Replaces: 12010293
SEAL-WIRE CABLE, Grey
 for Weather Pack Shrouds/Towers
 Wire Insulation Dia.: 2.81-3.49MM, (0.110-0.137) See chart
UNIT PACKAGE 50



99-8729

Replaces: 12015193
SEAL-WIRE CABLE, Blue
 for Weather Pack Shrouds/Towers
 Wire Insulation Dia.: 3.45-4.30MM, (0.136-0.169) See chart
UNIT PACKAGE 50



99-8730

Replaces: 12015323
SEAL-WIRE CABLE, Green
 for Weather Pack Shrouds/Towers
 Wire Insulation Dia.: 2.03-2.85MM, (0.080-0.112) See chart
UNIT PACKAGE 50

GAGE	TYPE		
	TXL	SXL	GXL
20	-----	99-8730	99-8730
18	-----	99-8730	99-8730
16	99-8730	99-8728	99-8730
14	99-8730	99-8729	99-8728
12	99-8728	99-8729	99-8728
10	99-8729	-----	-----

CROSS REFERENCE FROM HALOGEN BULB IND. # TO C-P REPAIR HARNESS

HALOGEN BULB TYPE	C-P REPAIR HARNESS	HALOGEN BULB TYPE	C-P REPAIR HARNESS
880	96-7583	9006/HB4	87-6235
881	89-6653	9007/HB5	87-6233
884	96-7583	9008/HB13	99-8509
885	96-7583	9055/HB12	87-6234
886	89-6653	9145/H10	87-6234
889	89-6653	H2	--
890	96-7583	H3	--
892	96-7583	H4	86-6091
893	96-7583	H7	99-8592
894	89-6653	H8	89-6653
896	89-6653	H9	99-8625
898	89-6653	H10/9145	87-6234
899	96-7583	H11	89-6653
9003/HB2/H4	86-6091	H12/9005	87-6234
9004/HB1	87-6233	H13/9008	99-8509
9005/HB3	87-6234		

NEW HEADLAMP & UNIVERSAL ELECTRICAL REPAIR HARNESSSES

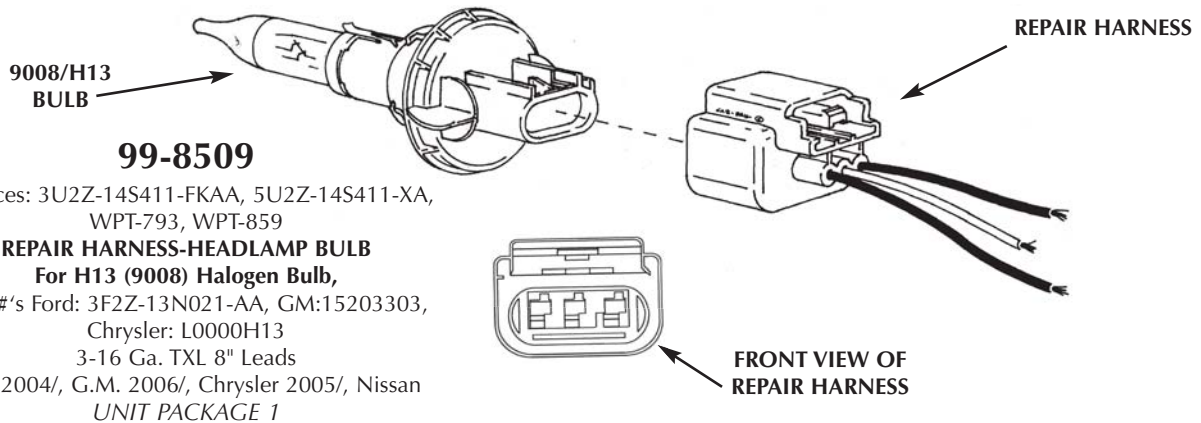

99-8509
 Replaces: 3U2Z-14S411-FKAA, 5U2Z-14S411-XA, WPT-793, WPT-859
REPAIR HARNESS-HEADLAMP BULB
 For H13 (9008) Halogen Bulb,
 Bulb #'s Ford: 3F2Z-13N021-AA, GM:15203303, Chrysler: L0000H13
 3-16 Ga. TXL 8" Leads
 Ford 2004/, G.M. 2006/, Chrysler 2005/, Nissan
 UNIT PACKAGE 1

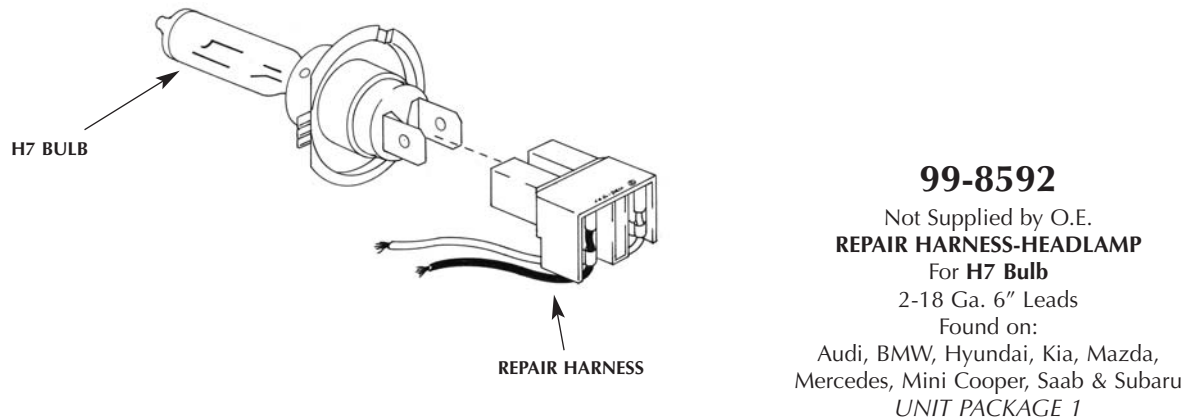

99-8592
 Not Supplied by O.E.
REPAIR HARNESS-HEADLAMP
 For H7 Bulb
 2-18 Ga. 6" Leads
 Found on:
 Audi, BMW, Hyundai, Kia, Mazda, Mercedes, Mini Cooper, Saab & Subaru
 UNIT PACKAGE 1

NEW HEADLAMP & UNIVERSAL ELECTRICAL REPAIR HARNESES

99-8625

Replaces: 88987187, PT1634
REPAIR HARNESS-HEADLAMP BULB
Bulb #H9
 2-18 Ga. TXL 8" Leads
 G.M., Audi, Porsche, Mini, VW, Volvo &
 Mazda '98/
 UNIT PACKAGE 1

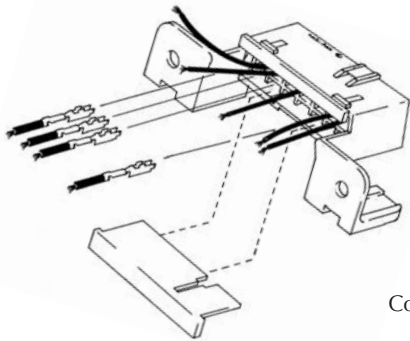
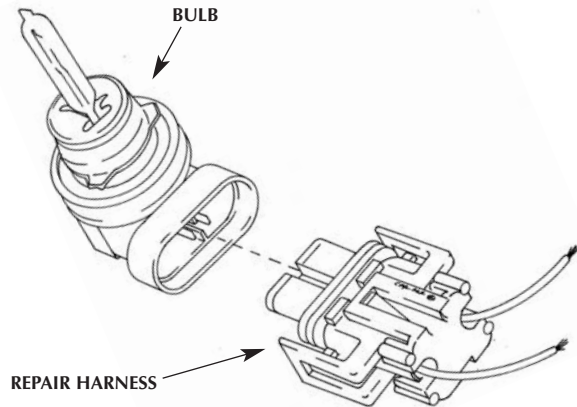

99-8621

Replaces: 12110250,
 3U2Z-14S411-LKA, WPT-615
REPAIR HARNESS KIT-DATA LINK
for OBDII
 Contents: 1-Connector, 2 Locks, 6-16ga,
 6 20 Ga. & 2-22 Ga. TXL 8" Leads
 All Cars & Lt Duty Trucks Built in the U.S.
 '96/
 UNIT PACKAGE 1



99-8670

Not Supplied by O.E.
REPAIR HARNESS-SWITCHES & SENSORS
 1-12ga GXL 12" LEAD
 Right Angle for " Male Spade Terminals
 Formerly 72-3773
 Ford, General Purpose
 UNIT PACKAGE 1

NEW ELECTRICAL REPAIR HARNESES FOR GENERAL MOTORS

99-8704

Replaces: 15862656, 88953358,
 PT1650, PT2195
REPAIR HARNESS-BLOWER MOTOR
RESISTOR (#'s 89019088, 89019089,
 89019100)
& VARIOUS RELAYS,
SWITCHES & ACTUATORS
 7-12ga TXL 8" Leads
 G.M. Lt. & Med. Duty Trucks & Cars '90/
 UNIT PACKAGE 1

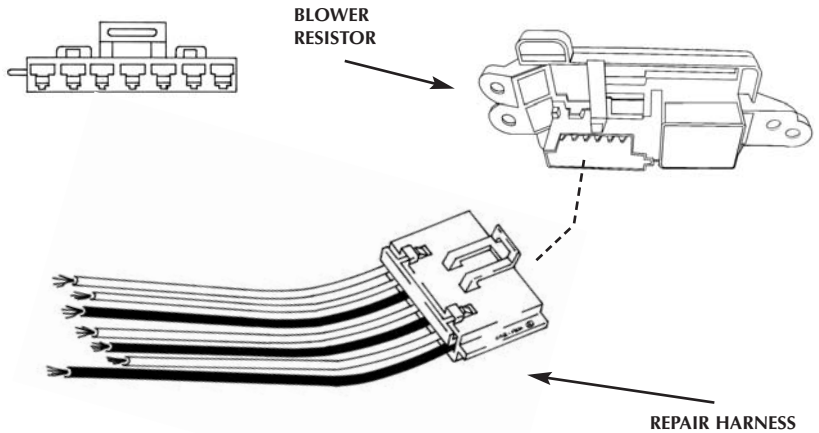

99-8702

Replaces: 12101881, PT152
REPAIR HARNESS-RELAY
 4 Lead Relay's with Shroud
 2-18ga & 2-12ga GPT 8" Leads
 G.M. '91-'93
 UNIT PACKAGE 1

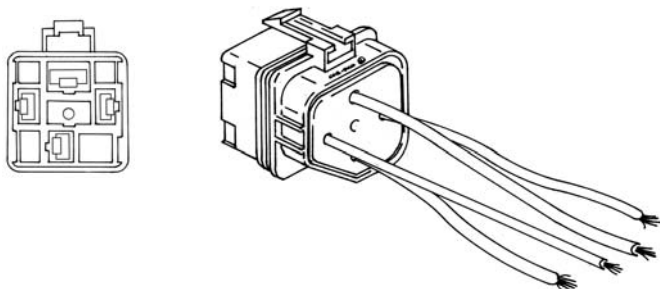

NEW ELECTRICAL REPAIR HARNESSES FOR GENERAL MOTORS

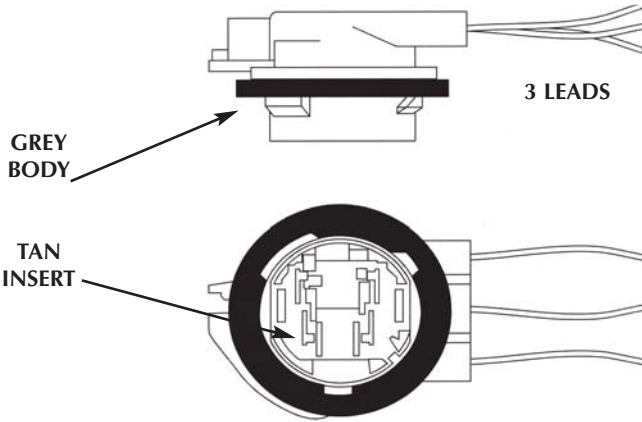

99-8651

Replaces: 12083680, 12159662, LS54
**REPAIR HARNESS- DAYTIME RUNNING,
 BACK-UP, CORNERING, PARK/TURN,
 STOP/TAIL & TAIL/TURN SIGNAL LAMPS**
Bulb #'s 3057, 3157, 3357, 4157, 4114K
 Body: Med. Grey, Insert: Tan
 3-18 Ga. TXL 8" Leads
 G.M. Cars & Trucks '99
 UNIT PACKAGE 1

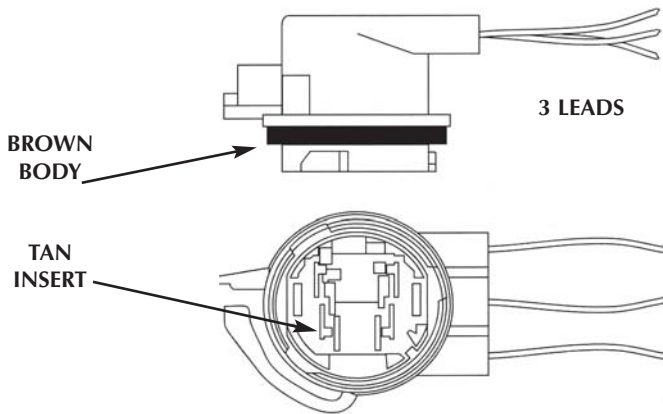

99-8652

Replaces: 15306147, LS92
**REPAIR HARNESS-PARK/TURN,
 STOP/TAIL & TURN SIGNAL LAMPS**
Bulb #'s 3057, 3157, 3357, 4157, 4114K
 Body: Brown, Insert: Tan
 3-18 Ga. TXL 8" Leads
 G.M. Lt. Duty Trucks '99/
 UNIT PACKAGE 1

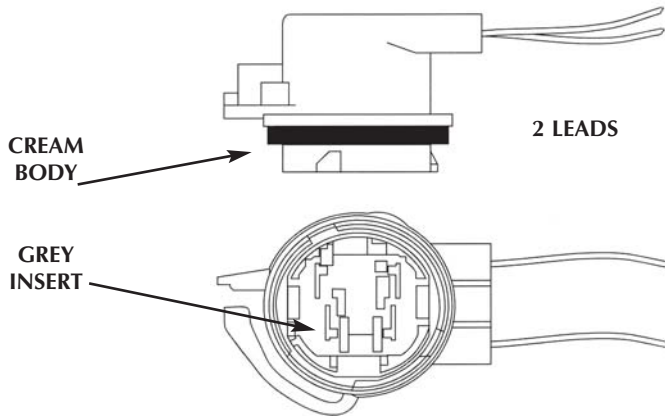

99-8653

Replaces: 15306312, LS97
**REPAIR HARNESS-BACK-UP
 & TURN SIGNAL LAMPS**
Bulb #'s 3156, 4156
 Body: Cream, Insert: Grey
 2-18 Ga. TXL 8" Leads
 G.M. Cars & Lt. Duty Trucks '99/
 UNIT PACKAGE 1

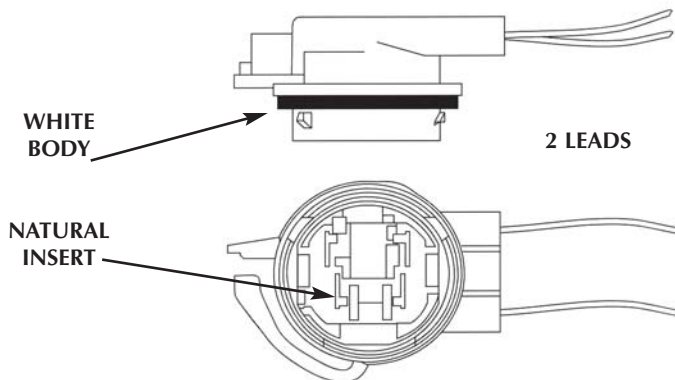

99-8654

Replaces: 15306157, LS94
**REPAIR HARNESS-DAYTIME RUNNING
 & TURN SIGNAL LAMPS**
Bulb #'s 3156, 4156
 Body: White, Insert: Natural
 2-18 Ga. TXL 8" Leads
 G.M. Cars & Lt. Duty Trucks '99/
 UNIT PACKAGE 1

NEW ELECTRICAL REPAIR HARNESSES FOR HEADLAMPS UNIVERSAL & GENERAL MOTORS PRODUCTS

NEW ELECTRICAL REPAIR HARNESSES FOR GENERAL MOTORS

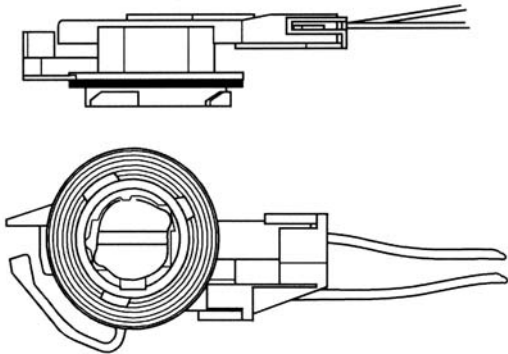

99-8594

Replaces: 12141301, LS39
REPAIR HARNESS-BACK-UP & FOG LAMP SOCKET
1156, 2056 Bulbs
 2-18 Ga. TXL 8" Leads
 G.M. '92-2003
UNIT PACKAGE 1

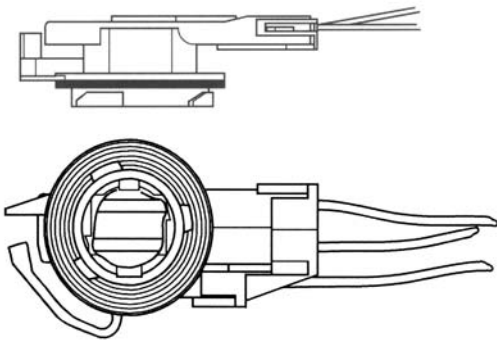

99-8595

Replaces: 15306194, 12141302, LS96, LS40
**REPAIR HARNESS- PARKING, TURN SIGNAL,
 TAIL & CORNERING LAMP SOCKET**
1157, 2057 Bulbs
 3-18 Ga. TXL 8" Leads
 G.M. '92-2004
UNIT PACKAGE 1

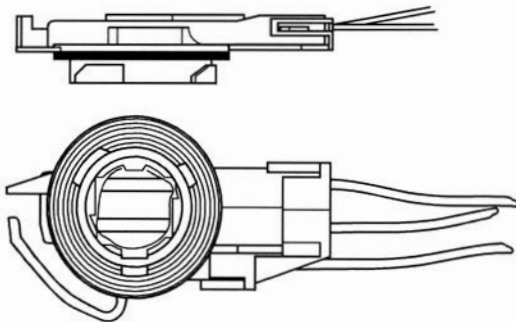

99-8596

Replaces: 12141493, LS49
**REPAIR HARNESS-BACK-UP, PARKING, TURN
 SIGNAL, STOP & TAIL LAMP SOCKET**
1157, 2057 Bulbs
 3-18 Ga. TXL 8" Leads
 G.M. '93-2005
UNIT PACKAGE 1

NEW ELECTRICAL REPAIR HARNESSES FOR CHRYSLER

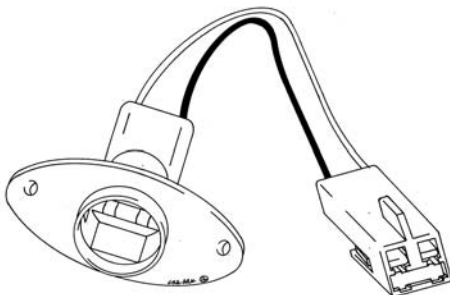

99-8634

Replaces: 4414184, 88860460, LS150
HARNES ASSEMBLY-LICENSE PLATE LAMP
 Molded lamp socket accepts **168 & 194 wedge
 based bulbs**. Connector mates with body harness.
 Chrysler Cars, Mini vans & Dodge Dakota '84-2004
UNIT PACKAGE 1

NEW LIGHTING SOCKETS FOR CHRYSLER

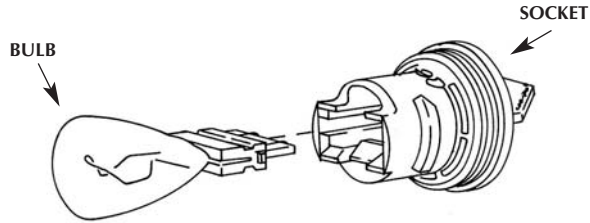

99-8613

Replaces: 4676589, 88860570, LS170
SOCKET-TAIL LAMP
3157 Bulb
 Chrysler Mini Vans,
 Dodge Trucks & Jeep Gr. Cherokee '96/
UNIT PACKAGE 1

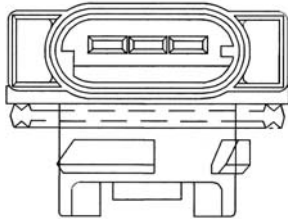

99-8694

Replaces: 4399900, 88860571, LS171
SOCKET-STOP, TAIL, TURN, PARKING
& MARKER LAMPS, 3157 Bulb
 Chrysler 'LH', Neon & Mini Vans
 Dodge Dakota, Durango & Vans
 '90-2003
UNIT PACKAGE 1

NEW FORD ELECTRICAL REPAIR HARNESSES

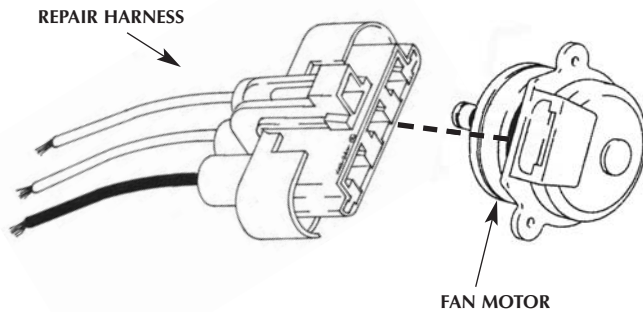

99-8581

Replaces: F8AZ-14A411-BA, 1U2Z-14S411-ADA,
 WPT-168, 88988310, PT1859
REPAIR HARNESS-RADIATOR COOLING FAN MOTOR
 Motor Base #8C607 F8CZ-AA, F8CZ-AB, F8VZ-AA, XR3Z-AA,
 3F1Z-GA , XR3Z-HA, 3-10 ga. TXL 8" Leads
 Ford, Lincoln, Mercury Cars, Ford Escape & Windstar '98/
UNIT PACKAGE 1

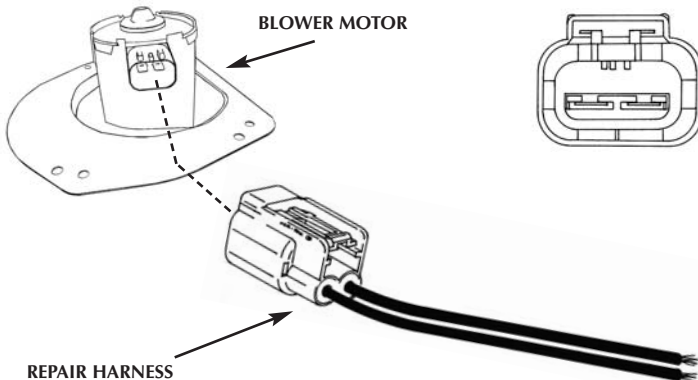

99-8712

Replaces: 4W7Z-14A411-B, 3U2Z-14S411-YBA,
 WT-56853, WPT-605
REPAIR HARNESS-HEATER BLOWER MOTOR
 Motor #4W7Z-19805-AA, MM929
(must be used when replacing original motor with
above motor for vehicles prior to 4/19/2004)
 2-12Ga TXL 8" Leads
 Ford Cars & Trucks '79/
UNIT PACKAGE 1

NEW ELECTRICAL REPAIR HARNESSES FOR G.M., CHRYSLER & FORD PRODUCTS

NEW FORD ELECTRICAL REPAIR HARNESSSES

1998 & UP 7.3 DIESEL

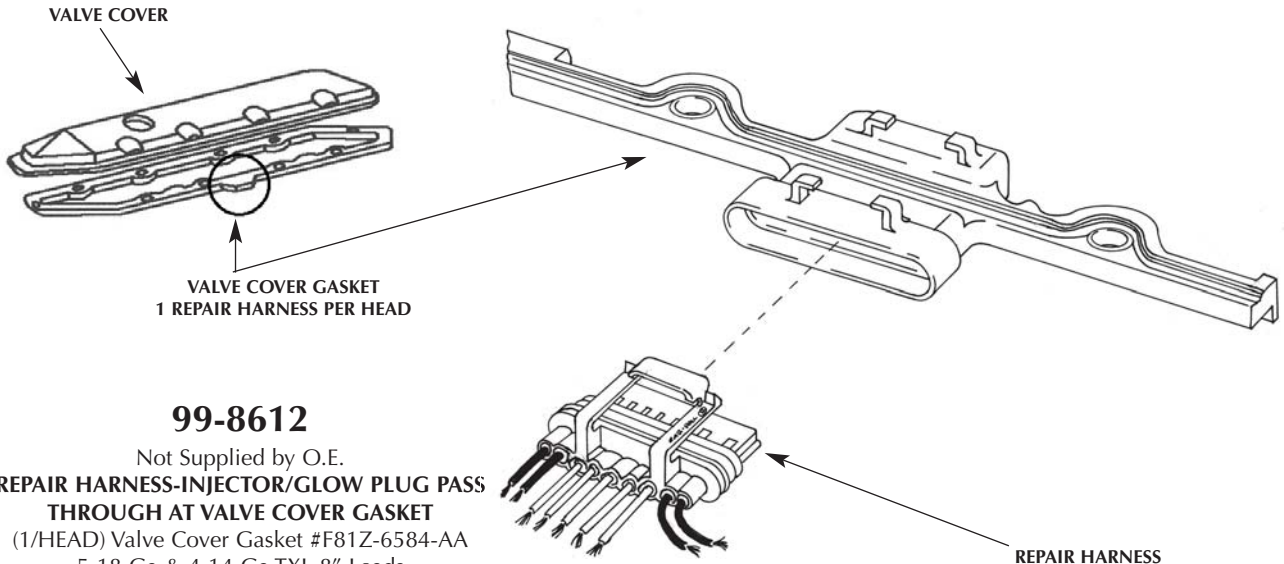

99-8612

Not Supplied by O.E.
REPAIR HARNESS-INJECTOR/GLOW PLUG PASS THROUGH AT VALVE COVER GASKET
 (1/HEAD) Valve Cover Gasket #F81Z-6584-AA
 5-18 Ga & 4-14 Ga TXL 8" Leads
 Ford E & F Series Trucks 7.3 Diesel '98/ & Excursion 2000/
 UNIT PACKAGE 1

1995 -1997 7.3 DIESEL

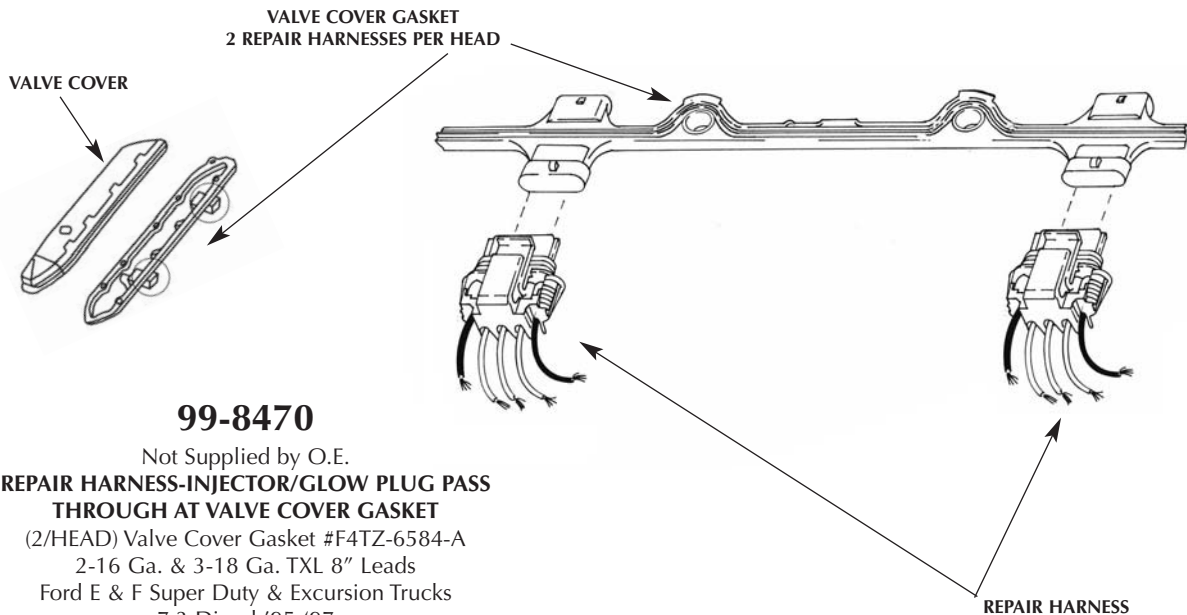

99-8470

Not Supplied by O.E.
REPAIR HARNESS-INJECTOR/GLOW PLUG PASS THROUGH AT VALVE COVER GASKET
 (2/HEAD) Valve Cover Gasket #F4TZ-6584-A
 2-16 Ga. & 3-18 Ga. TXL 8" Leads
 Ford E & F Super Duty & Excursion Trucks
 7.3 Diesel '95-'97
 UNIT PACKAGE 1

PREVIOUSLY ANNOUNCED

NEW FORD ELECTRICAL REPAIR HARNESSES

99-8481
 Replaces: 1U2Z-14S411-AJA, WPT-173
**REPAIR HARNESS-A/C COMPRESSOR
 CLUTCH & RADIO ANTENNA**
 2-14 Ga. TXL 8" Leads
 Ford Cars & Trucks '95/
 UNIT PACKAGE 1

99-8508
 Replaces: 3U2Z-14S411-EKA, 4U2Z-14S411-RA,
 WPT-254, WPT-837
**REPAIR HARNESS-REAR AXLE
 SPEED SENSOR**
 Sensor #'s 1L2Z-9E731-AA,
 1L2Z-9E731-AA,, DY887, DY1000
 2-20 Ga. TXL 8" Leads
 Ford Explorer/Mountaineer & Aviator 2002/
 UNIT PACKAGE 1

99-8522
 Replaces: 3U2Z-14S411-MHA, WPT-439
REPAIR HARNESS-OIL PRESSURE SWITCH
 Sw#'s F75Z-9278-CB, F8AZ-9278-DA, 1U5Z-9278-DA, SW-5192, SW-5696
 1-14Ga. TXL 8" Lead
 Ford Cars & Lt. & Med. Trucks '97/
 UNIT PACKAGE 1

99-8608
 Replaces: 3U2Z-14S411-EEA, WPT-312
REPAIR HARNESS-DOOR LOCK ACTUATOR
 Actuator Base #'s 218A42 & 218A43
 2 -14 Ga. TXL 8" Leads
 Ford Cars & Trucks '90/
 UNIT PACKAGE 1

NEW ELECTRICAL REPAIR HARNESSES FOR FORD PRODUCTS

ELECTRICAL REPAIR HARNESSES FOR FORD SOCKET BASES

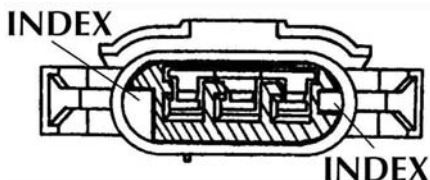
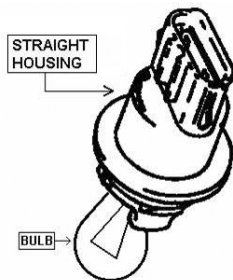
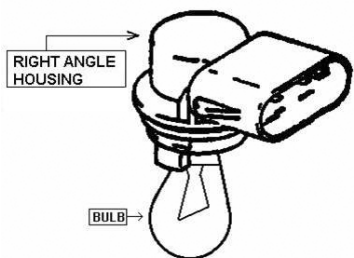

2 LEAD

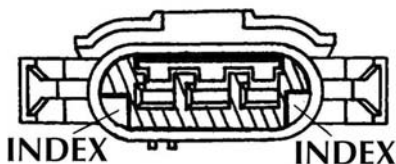

95-7429

Replaces: 1U2Z-14S411-DA, WPT-105,
3U2Z-14S411-BYA, WPT-211
REPAIR HARNESS-90° LAMP SOCKET BASES
Wedge Bulb
Gray Hardshell w/Tab Guide
2-18Ga TXL 8" Leads
Ford Ranger, Explorer, Econoline '91/
UNIT PACKAGE 1

96-7572

Replaces: 1U2Z-14S411-EA, WPT-106
REPAIR HARNESS-STRAIGHT LAMP SOCKET BASES
Wedge Bulb
Green Hardshell
2-18Ga TXL 8" Leads
Ford Windstar '95/
UNIT PACKAGE 1

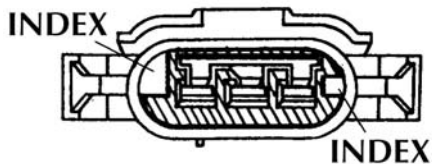
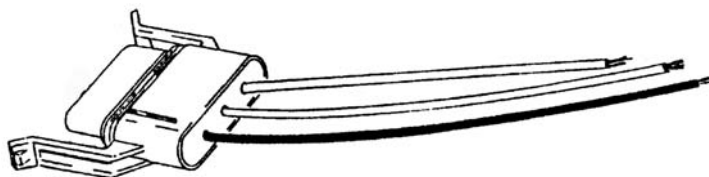

3 LEAD

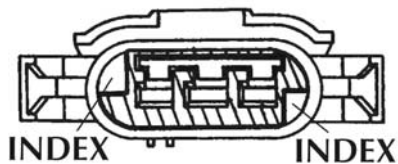

95-7428

Replaces: 1U2Z-14S411-GA, WPT-108
REPAIR HARNESS-90° LAMP SOCKET BASES
Wedge Bulb
Black Hardshell w/Tab Guide
3-18Ga TXL 8" Leads
Ford Ranger, Explorer, Econoline '91/
UNIT PACKAGE 1

96-7573

Replaces: 1U2Z-14S411-HA, WPT-109,
3U2Z-14S411-ECA, WPT-243
REPAIR HARNESS-STRAIGHT LAMP SOCKET BASES
Wedge Bulb
Brown Hardshell
3-18Ga TXL 8" Leads
Ford Windstar
UNIT PACKAGE 1

NEW ELECTRICAL REPAIR HARNESSES FOR FORD SOCKET BASES

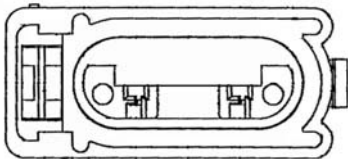
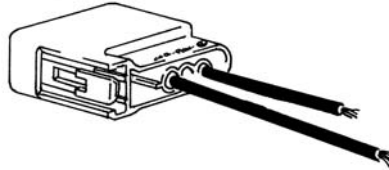
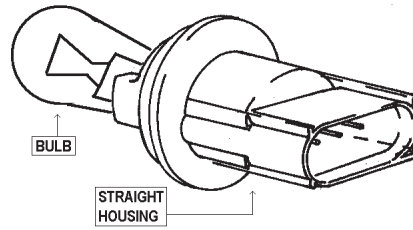
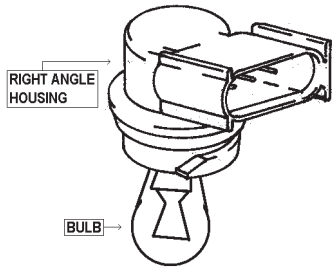

2 LEAD

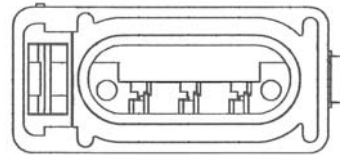

99-8532

Replaces: 3U2Z-14S411-DNAA, WPT-773
REPAIR HARNESS-STRAIGHT LAMP SOCKET BASES
 Wedge Bulb
 Green Hardshell
 2-18Ga TXL 8" Leads
 Ford Escape, F150, Taurus & Sable 2000/
UNIT PACKAGE 1

99-8534

Replaces: 3U2Z-14S411-DMAA, WPT-702,
 88988109, PT1786
REPAIR HARNESS-90° LAMP SOCKET BASES
 Wedge Bulb
 Gray Hardshell
 2-18Ga TXL 8" Leads
 Ford Focus, Escape, Explorer, Mountaineer,
 Expedition, Navigator, F150 & F Super Duty '98/
UNIT PACKAGE 1

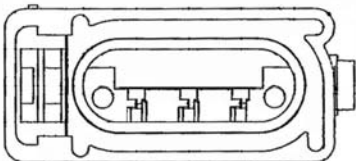
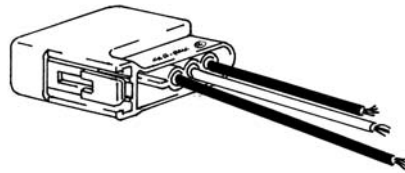

3 LEAD

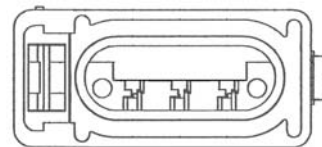

99-8533

Replaces: 88988117, PT1774
REPAIR HARNESS-STRAIGHT LAMP SOCKET BASES
 Wedge Bulb
 Brown Hardshell
 3-18Ga TXL 8" Leads
 Ford Focus, Escape, Ranger, Explorer, Mountaineer,
 F150 & F-Super Duty '98/
UNIT PACKAGE 1

99-8535

Replaces: 3U2Z-14S411-CKAA, WPT- 671,
 88988139, PT1783
REPAIR HARNESS-90° LAMP SOCKET BASES
 Wedge Bulb
 Black Hardshell
 3-18Ga TXL 8" Leads
 Ford Focus, Escape, Expedition, Navigator, Explorer,
 Mountaineer, Ranger, Freestar, Monterey,
 F150, F Super Duty & Excursion '95/
UNIT PACKAGE 1

NEW ELECTRICAL REPAIR HARNESSES FOR FORD SOCKET BASES

LIGHTING SOCKET BASES FOR FORD PRODUCTS

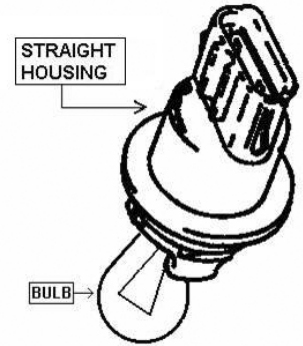
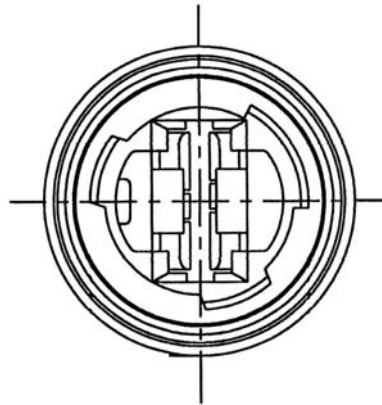
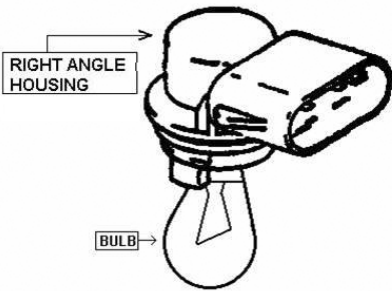

**STANDARD
LOCKING EARS**

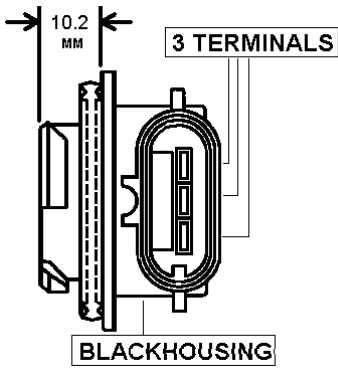

99-8291

Replaces: FITZ-13411-F, 88860591, LS184
**SOCKET-STOP, PARKING & TURN
 SIGNAL LAMPS, 3157 BULB,**
 Use W/95-7428 Harness
 Ford Cars & Trucks '91/
 UNIT PACKAGE 1

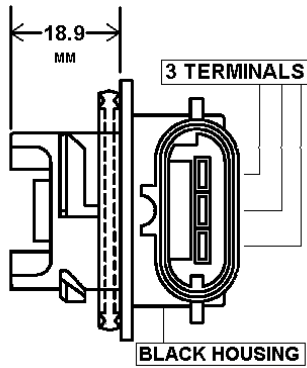

99-8292

Replaces: FITZ-13411-A, 88860592, LS185
**SOCKET-STOP, PARKING & TURN
 SIGNAL LAMPS, 3157 BULB,**
 Use W/95-7428 Harness
 Ford Cars & Trucks '94/
 UNIT PACKAGE 1

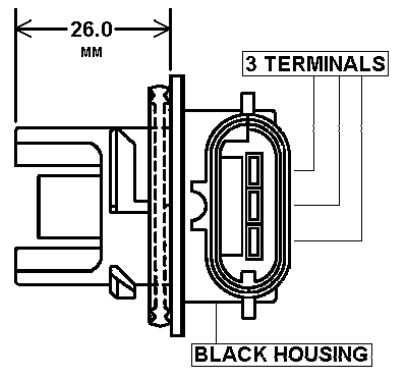

99-8293

Replaces: FITZ-13411-E
**SOCKET-STOP & TURN
 SIGNAL LAMPS, 3157 BULB,**
 Use W/95-7428 Harness
 Ford Cars & Trucks '97/
 UNIT PACKAGE 1

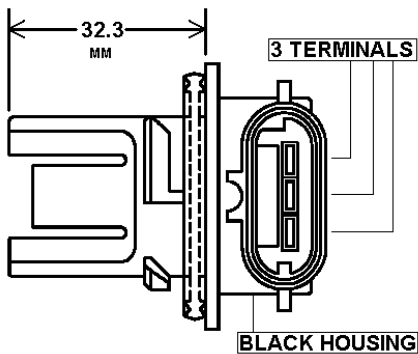

99-8294

Replaces: FITZ-13411-C,
 88860590, LS183
**SOCKET-BACK UP, PARKING &
 TURN SIGNAL LAMPS, 3157 BULB,**
 Use W/95-7428 Harness
 Ford Cars & Trucks '91/
 UNIT PACKAGE 1

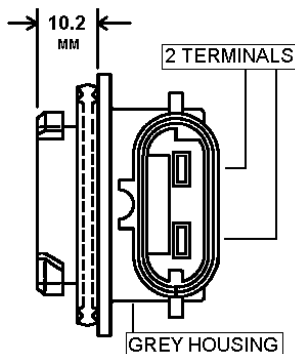

99-8295

Replaces: FITZ-13411-B,
 88861079, LS214
**SOCKET-BACK UP, PARKING & STOP
 LAMPS, 3156 BULB,**
 Use W/95-7429 Harness
 Ford Cars & Trucks '91/
 UNIT PACKAGE 1

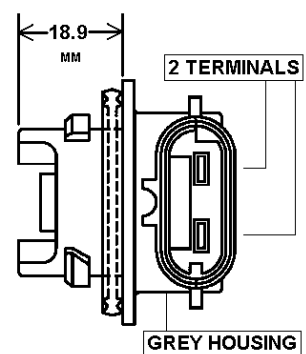

99-8296

Replaces: FITZ-13411-G,
 88861080, LS215
**SOCKET-BACK UP, PARKING & STOP
 LAMPS, 3156 BULB,**
 Use W/95-7429 Harness
 Ford Cars & Trucks '90/
 UNIT PACKAGE 1

NEW LIGHTING SOCKET BASES FOR FORD PRODUCTS

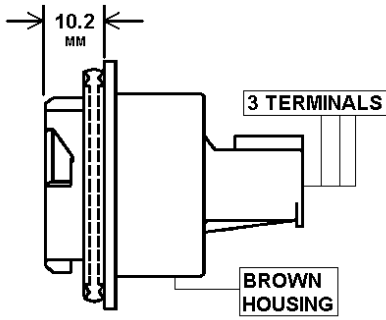

99-8297

Replaces: F3LY-13411-A, 88861081, LS216
SOCKET-PARKING & TURN SIGNAL LAMPS 3157 BULB,
 Use W/96-7573 Harness
 Ford Cars & Trucks '93/
 UNIT PACKAGE 1

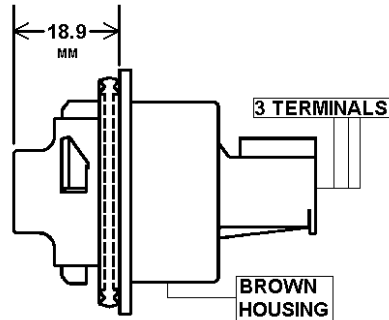

99-8298

Replaces: F47Z-13411-A, 88861082, LS217
SOCKET-STOP, TAIL & TURN SIGNAL LAMPS, 3157 BULB,
 Use W/96-7573 Harness
 Ford Cars & Trucks '94/
 UNIT PACKAGE 1

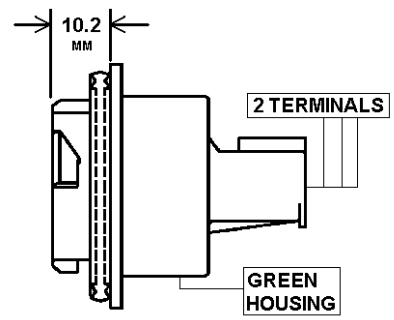

99-8299

Replaces: F58Z-13411-A, 88861083, LS218
SOCKET-TURN SIGNAL LAMPS 3156 BULB,
 Use W/96-7572 Harness
 Ford Cars & Trucks '95-2004
 UNIT PACKAGE 1

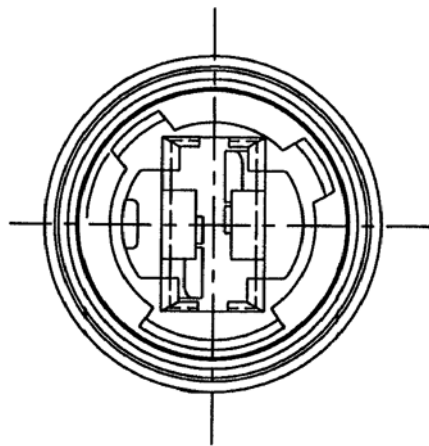
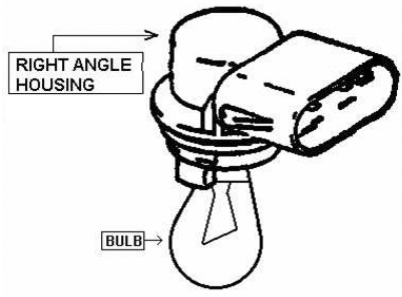

**40/60
 LOCKING EARS**

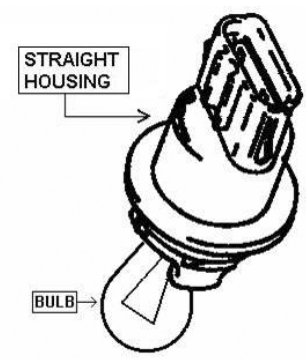

NEW FORD LIGHTING SOCKET BASES

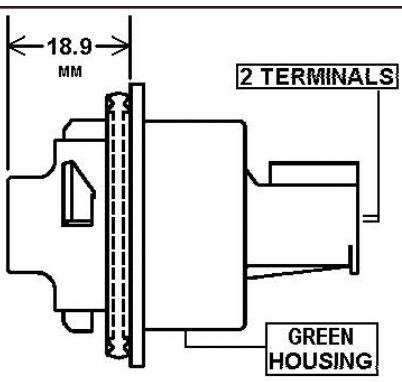

99-8542

Replaces: F37Z-13411-A
SOCKET-BACK UP & STOP/TAIL LAMPS, 3156 Bulb
 Green Straight Housing
 Use w/96-7572 Harness
 Ford Car's & Trucks '93-2004
 UNIT PACKAGE 1

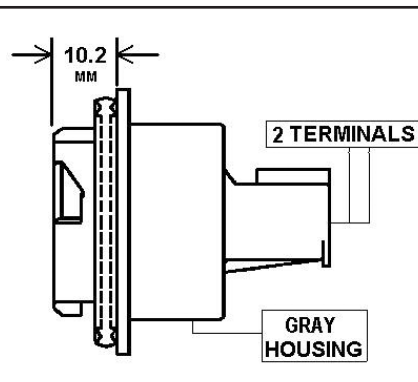

99-8543

Replaces: F6DZ-13411-B
SOCKET-SIGNAL LAMPS, 3156 Bulb
 Grey Straight Housing
 Use w/95-7429 Harness
 Ford Taurus/Sable &
 Mercury Villager '96-2002
 UNIT PACKAGE 1

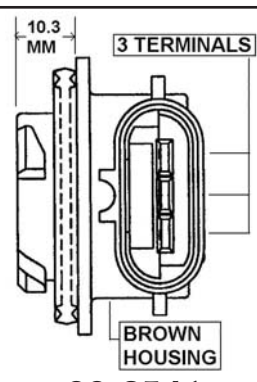

99-8541

Replaces: F6DZ-13411-A
SOCKET-STOP/TAIL/SIGNAL LAMPS 3157 Bulb
 Brown 90° Housing
 Use w/96-7573 Harness
 Ford Car's & Trucks '96/
 UNIT PACKAGE 1

NEW LIGHTING SOCKET BASES FOR FORD PRODUCTS

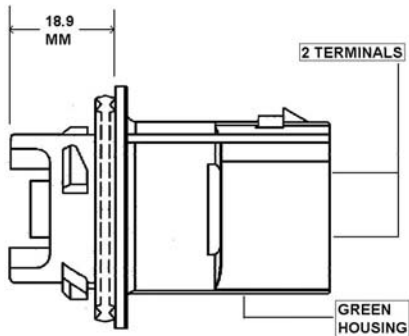
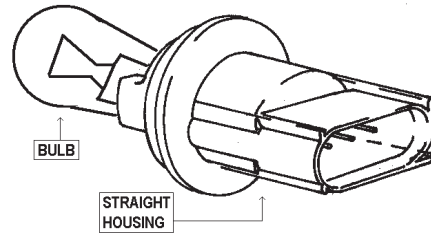
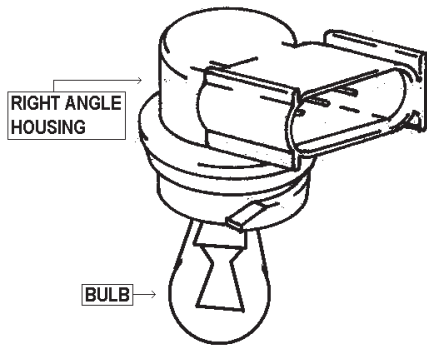

99-8530

Replaces: 2U5Z-13411-RA
SOCKET-BACK UP LAMPS
3156 Bulb
 Green Straight Housing
 Use w/**99-8532** Harness
 Ford Cars & Trucks 2000/
UNIT PACKAGE 1

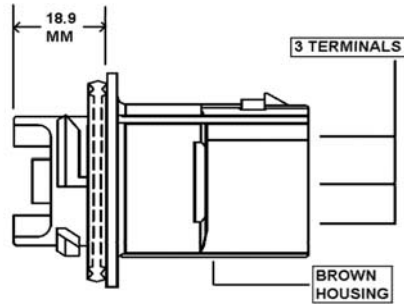

99-8531

Replaces: 2U5Z-13411-SA
SOCKET-PARK, TURN SIGNAL, TAIL & SIDE MARKER LAMPS, 3157 Bulb
 Brown Straight Housing
 Use w/**99-8533** Harness
 Ford Cars & Trucks '98/
UNIT PACKAGE 1

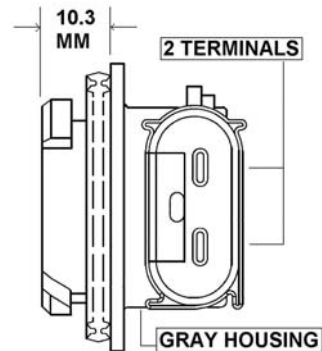

99-8536

Replaces: 2U5Z-13411-AA
SOCKET-BACK UP, STOP/TURN/TAIL LAMPS, 3156 Bulb
 Grey 90° Housing
 Use w/**99-8534** Harness
 Ford Cars & Trucks 2000/
UNIT PACKAGE 1

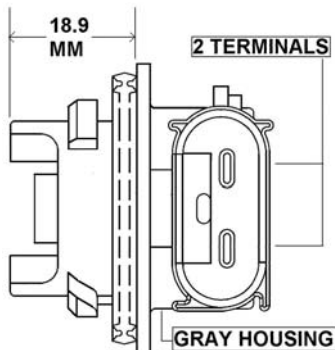

99-8537

Replaces: 2U5Z-13411-CA
SOCKET-BACK UP & STOP/TURN/TAIL LAMPS, 3156 Bulb
 Grey 90° Housing
 Use w/**99-8534** Harness
 Ford Cars & Trucks '98/
UNIT PACKAGE 1

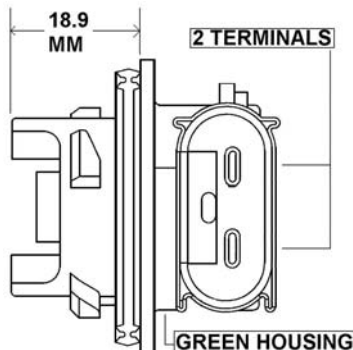

99-8538

Replaces: 2U5Z-13411-HA
SOCKET-SIGNAL LAMPS
3156 Bulb
 Green 90° Housing
 Use w/**99-8532** Harness
 Ford Escape 2003/
UNIT PACKAGE 1

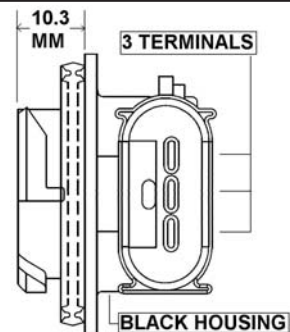

99-8539

Replaces: 2U5Z-13411-BB
SOCKET-BACK UP, PARK/TURN, STOP/TURN/TAIL LAMPS
3157 Bulb
 Black 90° Housing
 Use w/**99-8535** Harness
 Ford Cars & Trucks '99/
UNIT PACKAGE 1

NEW LIGHTING SOCKET BASES FOR FORD PRODUCTS

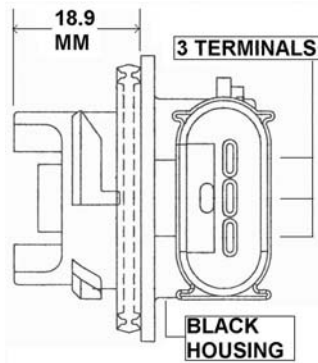

99-8540

Replaces: 2U5Z-13411-DA
**SOCKET-PARK/TURN, STOP/TURN/TAIL
 LAMPS, 3157 Bulb**
 Black 90° Housing
 Use w/**99-8535** Harness
 Ford Cars & Trucks '95/
UNIT PACKAGE 1

C-P NO.	REPL. O.E. #	APPLICATION	COLOR	NO. TERM.	MOUNT LENGTH	USE WITH HARNESS	UNIT PKG.
			ANGLE				
99-8291	F1TZ-13411-F, 88860591, LS184	91-97 MARQUIS, 2000-2007 FOCUS, 92-2007 TAURUS/SABLE, 94-2004 MUSTANG, 96-97 AEROSTAR, 2001-2005/ EXPLORER SPORT & SPORT TRAC, 92-2007 'E' VANS, 2000-2005 EXCURSION, 97-2004 'F' PICK UPS, 97/ EXPEDITION, 95-98 WINDSTAR, 93-97 RANGER, LINCOLN BLACKWOOD 2002	BLACK 90°	3	10.2MM	95-7428	1
99-8292	FT1Z-13411-A, 88860591, LS185	96/ 'E' VANS, 94-2004 MUSTANG, 2000/ LINCOLN LS, 99/ COUGAR, 98-2003 ESCORT, 96-99 TAURUS/SABLE, 2002-2005 THUNDERBIRD, 95-2005 EXPLORER/MOUN- TAINEEER, 99-2002 VILLAGER, 90-2007 RANGER, 97-2002 NAVIGATOR, 2001-2007 ESCAPE, 2003-2005 AVIA- TOR 97-2006 EXPEDITION, 99-2003 WINDSTAR,	BLACK 90°	3	18.9MM	95-7428	1
99-8293	F1TZ-13411-E	97/ ESCORT/TRACER, 2000-2005 EXCURSION, 97-2004 'F' PICK UPS, 97-2006 EXPEDITION/NAVIGATOR, 2001-2003 EXPLORER SPORT	BLACK 90°	3	26.0MM	95-7428	1
99-8294	F1TZ-13411-C, 88860590, LS183	2000/ FOCUS, 92-95 TAURUS/SABLE, 91-97 EXPLORER, 93-2006 NAVIGATOR, 93-98 VILLAGER	BLACK 90°	3	32.3MM	95-7428	1
99-8295	F1TZ-13411-B, 88861079, LS214	2000-2007 FOCUS, 96-2007 TAURUS/SABLE, 99/ CONTOUR/MYSTIQUE, 97-2002 ESCORT/TRACER, 91-2001 EXPLORER/MOUNTAINEEER, 93-98 VILLAGER, 91-2007 'E' VANS, 97-2004 EXPEDITION/NAVAGATOR, 95-98 WINDSTAR, 200-07 ESCAPE, 93-97 RANGER, 2003-2007 GR. MARQUIS/MARAUDER	GREY 90°	2	10.2MM	95-7429	1
99-8296	F1TZ-13411-G, 88861080, LS215	2000-2006 LINCOLN LS, 90-95 AEROSTAR, 2000-2005 EXCURSION, 90-2007 RANGER, 99-2003 WINDSTAR, 2002-2005 THUNDERBIRD, 2003-2006 EXPEDITION, 2001-2003 EXPLORER SPORT, 2003-2005 AVIATOR	GREY 90°	2	18.9MM	95-7429	1
99-8297	F3LY-13411-A, 88861081, LS216	95-2007 TOWN CAR, 93/98 MARK, 96-97 T.BIRD/COUGAR, 93-2003 ESCORT/TRACER, 96 AEROSTAR, 95-98 WINDSTAR, 2001-2005 EXPLORER SPORT TRAC, 96-99 TAURUS/SABLE	BROWN STRAIGHT	3	10.2MM	96-7573	1
99-8298	F47Z-13411-A, 88861082, LS217	96-97 T. BIRD/COUGAR, 97-2007 'F' PICK UPS, 98-2007 RANGER, 99-2007 CROWN VIC., 99-2004 MUSTANG, 98/ CONTOUR/MYSTIQUE, 96-97 AEROSTAR, 98/ NAVI- GATOR, 95-2003 WINDSTAR, 2001-2007 ESCAPE, 2002 BLACKWOOD, 97-2002 EXPEDITION, 97-2006 NAVI- GATOR, 2002-2005 EXPLORER/MOUNTAINEEER, 2003-2005 AVIATOR	BROWN STRAIGHT	3	18.9MM	96-7573	1
99-8299	F58Z-13411-A, 88861083, LS218	96/ TAURUS/SABLE, 95-2001 EXPLORER/MOUNTAINEEER, 97-2007 'F' PICK UPS, 95-98 WINDSTAR, 2001-2005 EXPLORER SPORT TRAC	GREEN STRAIGHT	2	10.2MM	96-7572	1

C-P NO.	REPL. O.E. #	APPLICATION	COLOR	NO. TERM.	MOUNT LENGTH	USE WITH HARNESS	UNIT PKG.
			ANGLE				
99-8530	2U5Z-13411-RA	2004-2007 F150 (NEW STYLE), 2000-2007 TAURUS/SABLE, 2007 EXPLORER SPORT TRAC, 2006-2007 MARK LT, 2006-2007 ZEPHYR/MKZ, 2006-2007 MILAN	GREEN STRAIGHT	2	18.9MM	99-8532	1
99-8531	2U5Z-13411-SA	2001/ ESCAPE, 2002-2005 EXPLORER/MOUNTAINEER, 2007 EXPLORER SPORT TRAC, 2004/ F150 (NEW STYLE), 2005/ FIVE-HUNDRED, 2000/ FOCUS, 2003/ CR. VICTORIA, 2005/ FREESTYLE, 2006/ FUSION, 2005/ MONTEGO, 2005/ MUSTANG, 98/ RANGER, 2008 TAURUS X, 2006/ MARK LT, 2003-2006 NAVIGATOR, 2003/ TOWN CAR, 2006/ ZEPHYR/MKZ, 2006/MILAN	BROWN STRAIGHT	3	18.9MM	99-8533	1
99-8536	2U5Z-13411-AA	2001/ ESCAPE, 97-2002 EXPEDITION/NAVIGATOR, 2000/ FOCUS, 2007 EDGE/MKX, 2004/ RANGER, 2006/ MOUNTAINEER	GREY 90°	2	10.3MM	99-8534	1
99-8537	2U5Z-13411-CA	2003-2006 EXPEDITION, 2000/ FOCUS, 2004/ FREESTAR/MONTEREY, 2004/ RANGER, 99-2003 WINDSTAR	GREY 90°	2	18.9MM	99-8534	1
99-8538	2U5Z-13411-HA	2003/ ESCAPE, 2002-2003 WINDSTAR	GREEN 90°	2	18.9MM	99-8532	1
99-8539	2U5Z-13411-BB	2004-2005 EXCURSION, 2000/ FOCUS, 99/ 'F' SUPER DUTY, 92/ 'E' VAN, 2006/ EXPLORER, 2001-2005 EXPLORER SPORT TRAC, 2007/ NAVIGATOR, 2005/ MARINER	BLACK 90°	3	10.3MM	99-8535	1
99-8540	2U5Z-13411-DA	2003/ ESCAPE, 2001-2002 EXPEDITION/NAVIGATOR, 95-2001 EXPLORER/ MOUNTAINEER, 2004/ FOCUS, 2004/ FREESTAR/MONTEREY, 2004/ RANGER, 2007/ EDGE/MKX, 2008 SUPER DUTY PICK UP	BLACK 90°	3	18.9MM	99-8535	1
99-8541	F6DZ-13411-A	2002-2005 EXPLORER/MOUNTAINEER, 2000/ FOCUS, 96-99 TAURUS/SABLE	BROWN 90°	3	10.3MM	96-7573	1
99-8542	F37Z-13411-A	97-2004 'F' PICK UPS, 93-2000 RANGER, 96-99 TAURUS/SABLE	GREEN STRAIGHT	2	18.9MM	96-7572	1
99-8543	F6DZ-13411-B	96-99 TAURUS/SABLE, 99-2002 VILLAGER	GREY STRAIGHT	2	10.2MM	95-7429	1

MAKE	MODEL	YEAR	LAMP LOCATION	SOCKET	HARNESS
FORD	CROWN VICTORIA	2003-2005	PARKING/SIGNAL	99-8298	96-7573
	ESCORT	1997-2002	BACK UP	99-8295	95-7429
	ESCORT ZX2 COUPE	1998-2003	BACK UP	99-8295	95-7429
		1998-2003	PARKING/SIGNAL	99-8297	96-7573
	FIVE HUNDRED	1998-2003	SIGNAL/STOP/TAIL	99-8292	95-7428
		2005	PARKING/SIGNAL	99-8531	99-8533
	FOCUS	2004	SIGNAL	99-8536	99-8534
		2004	STOP/TAIL	99-8539	99-8535
		2004	SIGNAL	99-8539	99-8535
		2005	SIGNAL	99-8531	99-8533
		2005	BACK UP	99-8537	99-8534
		2005	STOP/TAIL	99-8537	99-8534
		2000-2003	BACK UP	99-8295	95-7429
		2000-2003	SIGNAL	99-8541	96-7573
		2000-2004	SIGNAL/STOP/TAIL	99-8536	99-8534
		2000-2005	SIGNAL	99-8294	95-7428
		2000-2007	STOP/TAIL	99-8291	95-7428
		2004-2005	SIDE MARKER	99-8294	95-7428
		2004-2005	STOP/TAIL	99-8540	99-8535
		MUSTANG	2005	PARKING/SIGNAL	99-8531
	1994-2004		PARKING/SIGNAL	99-8291	95-7428
	1999-2000		MARKER/SIGNAL	99-8298	96-7573
	2001-2002		PARKING/SIGNAL	99-8292	95-7428
	TAURUS	1996-1999	REFLECTOR	99-8543	95-7429
		1996-1999	SIGNAL	99-8541	96-7573
		1996-1999	SIGNAL	99-8292	95-7428
		1996-1999	STOP/TAIL	99-8541	96-7573
		1996-2007	STOP/TAIL	99-8291	95-7428
		2000-2006	PARKING/SIGNAL	99-8291	95-7428
	TAURUS SW	2000-2006	SIGNAL	99-8295	95-7429
		1996-1999	REFLECTOR	99-8542	96-7572
	THUNDERBIRD	2000-2006	BACK UP	99-8530	99-8532
		2002-2005	BACK UP	99-8296	95-7429
	ECONOLINE VAN	2002-2005	SIGNAL	99-8292	95-7428
		2002-2005	STOP/TAIL	99-8292	95-7428
		1992-2006	BACK UP	99-8295	95-7429
		1992-2007	PARKING/SIDE MARKER	99-8291	95-7428
	ESCAPE	1992-2007	STOP/TAIL	99-8291	95-7428
		2005-2006	SIGNAL	99-8531	99-8533
		10/16/2003-2005	BACK UP	99-8536	99-8534
		10/16/2003-2005	SIGNAL	99-8538	99-8532
		10/16/2003-2005	STOP/TAIL	99-8540	99-8535
		2001-10/15/2003	STOP/TAIL	99-8292	95-7428
		2001-10/15/2003	BACK UP	99-8295	95-7429
		2001-2006	SIGNAL	99-8298	96-7573
		2004	PARKING/SIGNAL	99-8539	99-8535
		2000-2007	PARKING/SIGNAL	99-8291	95-7428
EXCURSION	2000-2004	BACK UP	99-8296	95-7429	
	2000-2005	SIGNAL/STOP/TAIL	99-8293	95-7428	
	2003	BACK UP	99-8296	95-7429	
	2003-2006	PARKING/SIGNAL	99-8292	95-7428	
EXPEDITION	2003-2006	SIGNAL/STOP/TAIL	99-8293	95-7428	
	1997-1999	BACK UP	99-8295	95-7429	
	1997-2000	SIGNAL/STOP/TAIL	99-8293	95-7428	
	1997-2002	PARKING/SIGNAL	99-8298	96-7573	
	1998-2000	SIGNAL/STOP/TAIL	99-8292	95-7428	
	2000-2002	BACK UP	99-8536	99-8534	
	2001-2002	SIGNAL/STOP/TAIL	99-8540	99-8535	
	2004-2006	BACK UP	99-8537	99-8534	
	2004-2006	PARKING/SIGNAL	99-8540	99-8535	
	2001	PARKING/SIGNAL	99-8540	99-8535	
	1991-1994	STOP/TURN	99-8294	95-7428	
	1991-2001	TAIL	99-8295	95-7429	
	EXPLORER	1995-2005	PARKING/SIGNAL	99-8292	95-7428
1995-2001		SIGNAL/STOP/TAIL	99-8299	96-7572	
2002-2003		PARKING/SIGNAL	99-8298	96-7573	
2002-2005		SIGNAL/STOP/TAIL	99-8292	95-7428	
2002-2005		STOP/TAIL	99-8541	96-7573	
2004-2005		SIDE MARKER	99-8531	99-8533	
2001-2003		BACK UP	99-8296	95-7429	
2001-2003		PARKING/SIGNAL	99-8291	95-7428	
EXPLORER SPORT	2001-2003	SIGNAL/STOP/TAIL	99-8293	95-7428	
	2001-2004	SIGNAL/STOP/TAIL	99-8297	96-7573	
	2001-2004	BACK UP	99-8299	96-7572	
EXPLORER SPORT TRAC	2001-2005	PARKING/SIGNAL	99-8291	95-7428	
	1999-2003	BACK UP	99-8299	96-7572	
F SERIES SUPER DUTY	1999-2007	PARKING/SIGNAL	99-8291	95-7428	

MAKE	MODEL	YEAR	LAMP LOCATION	SOCKET	HARNESS
FORD TRUCK (CONT)	F SERIES SUPER DUTY (CONT)	1999-2003	STOP/TAIL	99-8298	96-7573
		1999-2003	PARKING	99-8539	99-8535
		2004-2005	STOP/TAIL	99-8531	99-8533
		2004-2005	PARKING/SIGNAL	99-8539	99-8535
	F150 (NEW STYLE)	2004-2006	BACK UP	99-8530	99-8532
		2004-2006	PARKING/SIGNAL	99-8531	99-8533
	F150, F150 HERITAGE, F250 LD	1997-2004	BACK UP	99-8293	95-7428
		1997-2004	BACK UP	99-8299	96-7572
		1997-2004	PARKING/SIGNAL	99-8291	95-7428
		1997-2004	TAIL	99-8293	95-7428
		1997-2004	TAIL	99-8298	96-7573
	FREESTYLE	1997-2004	TAIL	99-8542	96-7572
		2005	PARKING/SIGNAL	99-8531	99-8533
		2004-2005	BACK UP	99-8537	99-8534
		2004-2005	CORNERING	99-8540	99-8535
	RANGER	2004-2005	SIGNAL/STOP/TAIL	99-8540	99-8535
		1993-1997	PARKING/SIGNAL	99-8291	95-7428
		1993-1997	SIGNAL	99-8296	95-7429
		1993-1997	STOP	99-8542	96-7572
		1993-2003	BACK UP	99-8296	95-7429
		1998-2000	BACK UP	99-8542	96-7572
		1998-2007	SIGNAL/STOP/TAIL	99-8292	95-7428
		1998-2007	PARKING	99-8292	95-7428
		1998-2003	SIGNAL/STOP/TAIL	99-8296	95-7429
		1998-2005	PARKING	99-8298	96-7573
		2004-2005	PARKING	99-8531	99-8533
		2004-2005	BACK UP	99-8537	99-8534
		2004-2005	SIGNAL/STOP/TAIL	99-8540	99-8535
	WINDSTAR	1995-1996	PARKING	99-8297	96-7573
		1995-1998	BACK UP	99-8295	95-7429
		1995-1998	SIGNAL/STOP/TAIL	99-8299	96-7572
		1997-1998	PARKING	99-8298	96-7573
		1999-2003	STOP/TAIL	99-8292	95-7428
1999-2003		PARKING/SIGNAL	99-8298	96-7573	
LINCOLN	LS	2000-2005	BACK UP	99-8296	95-7429
	MARK VIII	1993-1998	PARKING	99-8297	96-7573
	MARK LT	2006	BACK UP	99-8530	99-8532
	TOWN CAR	2003-2005	PARKING/SIGNAL	99-8297	96-7573
LINCOLN TRUCK	AVIATOR	2003-2004	PARKING/SIGNAL	99-8296	95-7429
		2003-2004	BACK UP	99-8296	95-7429
		2003-2005	SIGNAL/STOP/TAIL	99-8292	95-7428
	BLACKWOOD	2002	PARKING/SIGNAL	99-8298	96-7573
		2002	STOP/TAIL	99-8291	95-7428
	NAVIGATOR	2003	BACK UP	99-8293	95-7428
		2003-2006	STOP/TURN	99-8294	95-7428
		1997-2002	PARKING/SIGNAL	99-8298	96-7573
		2000-2002	BACK UP	99-8536	99-8534
		2001-2002	SIGNAL/STOP/TAIL	99-8540	99-8535
MERCURY	2003-2005	PARKING	99-8298	96-7573	
	2004-2006	PARKING	99-8531	99-8533	
	GRAND MARQUIS	2003-2004	PARKING/SIGNAL	99-8295	95-7429
	MARAUDER	2003-2004	PARKING/SIGNAL	99-8295	95-7429
	MONTEGO	2005	PARKING/SIGNAL	99-8531	99-8533
	SABLE	1996-1999	REFLECTOR	99-8295	95-7429
		1996-1999	SIGNAL	99-8297	96-7573
1996-1999		SIGNAL	99-8541	96-7573	
1996-1999		SIGNAL	99-8292	95-7428	
1996-1999		STOP/TAIL	99-8541	96-7573	
1996-2004		STOP/TAIL	99-8291	95-7428	
TRACER	2000-2004	PARKING/SIGNAL	99-8291	95-7428	
MERCURY TRUCK	MONTEREY	1997-2003	BACK UP	99-8295	95-7429
		2004-2005	BACK UP	99-8537	99-8534
	MOUNTAINEER	2004-2005	SIGNAL/STOP/TAIL	99-8540	99-8535
		1995-2001	PARKING/SIGNAL	99-8292	95-7428
		1995-2001	SIGNAL/STOP/TAIL	99-8299	96-7572
		1995-2001	TAIL	99-8295	95-7429
		2002-2003	PARKING/SIGNAL	99-8298	96-7573
	VILLAGER	2002-2005	SIGNAL/STOP/TAIL	99-8292	95-7428
		2002-2005	STOP/TAIL	99-8541	96-7573
		1993-1998	PARKING	99-8294	95-7428
		1993-1998	SIGNAL	99-8295	95-7429
		1999-2002	PARKING	99-8292	95-7428
		1999-2002	SIGNAL	99-8543	95-7429





CAR-PAK
AUTOMOTIVE BODY MAINTENANCE PARTS
CATALOGUE SUPPLEMENT

November 2010

**ALL NEW PARTS
 JUST RELEASED**



**SUPPLEMENT NO. 1 TO
 CAR-PAK CATALOGUE 2010**



TABLE OF CONTENTS

• • • *New Items Not Previously Available* • • •

Numerical Index2
 All New Items For General Motors Products3-4
 All New Items For Ford Products4
 All New Items For Chrysler Products5
 All New Items For Import Products5-6
 All New Electrical Repair Harnesses7
 All New Fuel Line Clips for Ford Products6
 All New General Purpose Fasteners8
 All New 'Answer' Assortment8



**USE THIS SUPPLEMENT ALONG WITH THE NEWLY COMBINED
CAR-PAK & JOBBERS SUPPLY CATALOG**

**THE CAR-PAK CATALOG CAN BE VIEWED AND DOWNLOADED
BY SECTION ON THE MAIN PAGE AT**

www.carpak.com

**OR AS A COMPLETE BOOKLET ON
THE 'REGISTERED USER' (DISTRIBUTORS ONLY) PAGE**

NOT A REGISTERED DISTRIBUTOR YET?

REQUEST A LOGIN VIA EMAIL TO

carpak@carpak.com

NUMERICAL INDEX

PART #	PAGE #	PART #	PAGE #	PART #	PAGE #
99-82127	99-88288	99-88474, 5
99-88034, 5	99-88295	99-88483
99-88054, 5	99-88307	99-88493
99-88115	99-88314	99-88504
99-88138	99-88324	99-88514
99-88148	99-88336	99-88525
99-88158	99-88346	99-88533
99-88165	99-88356	99-88553
99-88175	99-88363, 5, 6	99-88575
99-88185	99-88373	99-88587
99-88196	99-88383	99-88595
99-88206	99-88393	99-88606
99-88214	99-88406	99-88623
99-88223	99-88416	99-88633
99-88234	99-88426	AN9278
99-88244	99-88436	AN9288
99-88254	99-88446	AN9298
99-88264	99-88453	AN9308
99-88278				

LATEST NEW ITEMS FOR G.M. PRODUCTS

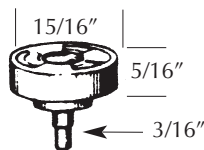

99-8845

Replaces: 3069189
ROLLER-WINDOW REGULATOR TO CHANNEL
 Formerly 65-1093
 G.M. '65/, S/T Truck '94/
 G.M. 'J' Body '82 / '91, Ford '71
UNIT PACKAGE 5



99-8863

Replaces: 5482087
CLIP-GRILLE MOUNTING
 Plastic
 G.M. Equinox 2005/
UNIT PACKAGE 15



99-8848

Replaces: 13252119
RETAINER-DOOR PANEL
 Plastic-Green
 Hole: M7.4, Top Hd: 15MM,
 O/L: 20MM, Slot: 2.6MM,
 Stem Lgth: 16MM, P.R.: 1.75-2.0MM
 G.M. Equinox, Terrain,
 Cadillac SRX 2010/ & Buick Regal 2011
UNIT PACKAGE 25



99-8849

Replaces: 13252118
RETAINER-DOOR PANEL
 Plastic-Blue
 Hole: M7.4, Top Hd: 13MM,
 O/L: 20MM, Slot: 2.6MM,
 Stem Lgth: 13MM, P.R.: 0.7-0.9MM
 G.M. Equinox, Terrain &
 Cadillac SRX 2010/
UNIT PACKAGE 25



99-8853

Replaces: 11561654
RETAINER-COWL,
 WINDSHIELD & DOOR PILLAR,
 INTERIOR TRIM PANELS, Plastic
 Hole: M8, Upper Hd: 13MM,
 O/L: 22MM, Trim Thk: 2.5MM
 G.M. Cars & Trucks 2006/
 Saturn 2007-2009, Hummer 2009
UNIT PACKAGE 15



99-8862

Replaces: 94530385
RETAINER-LOWER DOOR MOULDING
 Plastic w/Seal
 Hole: 7x8MM, Sec Hole: 5x8MM,
 Top Head: 12x14MM,
 Stem Lgth: 13MM, O/L: 19MM
 Saturn Vue 2008/
UNIT PACKAGE 10



99-8822

Replaces: 94530742
RETAINER-FENDER, WHEEL, SIDE & BUMPER MOULDINGS
 Plastic, w/Seal
 Hole: M8, Top Hd: 11x15MM, O/L: 15MM, Stem Lgth: 10MM
 Saturn Vue 2008-2009
UNIT PACKAGE 15



99-8837

Replaces: 15802005
RETAINER-FENDER & HEADLINER
 Plastic, Textured
 Hole: M7, Head: 25.4MM, Stem Lgth: 26MM, O/L: 29MM, P.R.: 1-13MM
 Buick Enclave, Chevrolet Traverse & Camaro, GMC Acadia & Saturn Outlook 2008/
UNIT PACKAGE 25

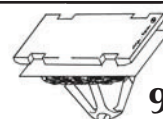

99-8838

Replaces: 11562250, 11571175
RETAINER-ROCKER MOULDING & FRONT SIGNAL LAMP
 Plastic w/Seal
 Hole: M9, Head: 12x20MM,
 O/L: 16MM, Stem Lgth: 11MM,
 Slot: 2.5MM, P.R. 0.08
 G.M. Enclave, Equinox, Traverse, Acadia, Terrain, 2005/, Cadillac SRX 2010, Saturn Outlook & Relay 2005/
UNIT PACKAGE 15

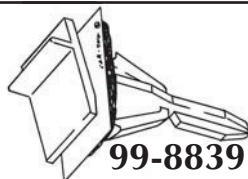

99-8839

Replaces: 25775903
RETAINER-ROCKER MOULDING
 Plastic w/Seal
 Hole: M9, Head: 12x16MM,
 O/L: 35MM, Stem Lgth: 24MM,
 P.R.: 0.75
 G.M. Enclave, Traverse, Acadia & Saturn Outlook 2007/
UNIT PACKAGE 10

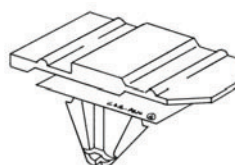

99-8855

Replaces: 25922739
RETAINER-ROCKER MOULDING
 Plastic-Green
 Hole: M9, Top Hd.: 12x29MM
 G.M. Enclave, Traverse & Acadia 2009/
UNIT PACKAGE 25

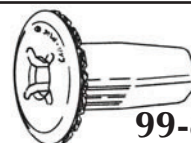

99-8836

Replaces: 5480766, 90189-06084, 09148-05035
GROMMET-TAIL LAMP, FENDER APRON, LICENSE PLATE, DOOR PANEL
 Plastic w/Seal
 Hole: M9, Flange: 18MM, O/L: 18MM,
 P.R.: 0.8-1.0MM, Screw: M6
 Chevrolet Equinox 2005/, Toyota Camry, Previa '88-2001, Suzuki SX4 2007-2009
UNIT PACKAGE 10

LATEST NEW ITEMS FOR G.M. & FORD PRODUCTS



99-8821

Replaces: 25910528
SCREW-LICENSE PLATE
 M6-1.0 x 12MM
 Finish: Silver Dacromet
 Cadillac SRX & General Purpose
UNIT PACKAGE 50



99-8823

Replaces: 11588441
**PUSH NUT-FENDER, QTR PANEL
 & GRILLE**
 For Non-Threaded Studs
 M6 X 24MM
 Zinc Finish
 GM Cars & Trucks 2002/, & Hummer
UNIT PACKAGE 50

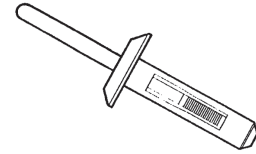

99-8824

Replaces: 11588308
**BLIND RIVET-NYLON, FRONT GRILLE,
 BUMPER & ROCKER MOULDING**
 Hole: M5, Flange: 9MM, G.R.: 3-6MM
 Buick Lucerne, Cadillac DTS/CTS 2006/
 & G.M. 'U' Body Van '97-2005
UNIT PACKAGE 25

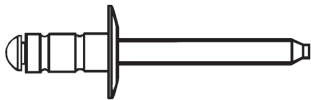

99-8825

Replaces: 15856741
BLIND RIVET-REAR BUMPER COVER
 Multi-Grip Type
 Aluminum Rivet/Steel Mandrel
 1/4" Rivet, 1/2" Flange, 0.080-0.350 G.R.,
 25/32" Rivet Length
 Buick Lucerne 2006/ & General Purpose
UNIT PACKAGE 15

NEW FORD

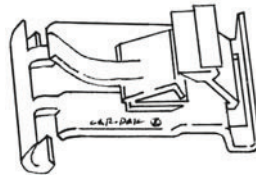

99-8832

Not Supplied by O.E.
RETAINER-BELT MOULDING
 Plastic
 Ford Taurus 2010/
UNIT PACKAGE 10



99-8805

Replaces: 3M8Z-17C432-A,
 GK2A-50-798
GROMMET-COWL VENT, Plastic-w/Seal
 Hole: 10x16MM, Flange: 15x27MM,
 P.R.: 1.6MM, Screw: M5
 Ford Fusion, Milan, Zepher & MKZ 2006/
 Mazda 6 2003-2008
UNIT PACKAGE 5

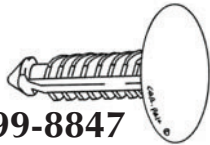

99-8847

Replaces: 5R3Z-54310D12-BAA,
 G032-68-865A-00
**RETAINER-HOOD, COWL
 INSULATORS & CARPET, Plastic-**
 Textured
 Hole: M6, Head: 20MM, O/L: 17MM,
 Stem Lgth: 15MM, P.R.: 2.6-5.7
 Ford Mustang 2005/
 Mazda 5, Miata, 626 & Protoge '98/
UNIT PACKAGE 25



99-8803

Replaces: 3M8Z-16K262-A, GJ6A-50-ES1
GROMMET-REAR BUMPER
 Plastic-w/Seal
 Hole: 17x20MM, Flange: 27x30MM,
 O/L: 33.5MM, P.R.: 0.6-1.0MM
 Ford Fusion, Lincoln MKS, Zepher/MKZ,
 Mercury Milan 2006/
 Mazda 6 2003/
UNIT PACKAGE 5

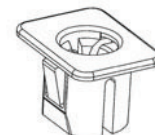

99-8850

Replaces: W711079-S300
GROMMET-TAIL LAMP
 Stud Retaining, Plastic
 Hole: 10x15MM,
 Flange: 13x17MM, O/L: 11MM
 Ford Explorer/Mountaineer
 & Pick Ups 2006/
UNIT PACKAGE 25

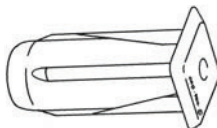

99-8851

Replaces: W708580-S300
**GROMMET-MARKER & TAIL LAMPS,
 BUMPERS**
 Plastic, Closed End
 Hole: M7.7, Flange: 12MM,
 O/L: 19MM, P.R.: 0.8MM
 Ford Fusion/Milan/MKZ,
 Expedition/Navigator 2006/
UNIT PACKAGE 25



99-8826

Replaces: W711858-S300
**RETAINER-HOOD & DOOR
 WEATHERSTRIP**
 Hole: M5, Top Hd: 5x15MM,
 O/L: 12.5MM, P.R.: 0.74 & 2.0MM
 Ford Edge & MKX 2007/
UNIT PACKAGE 100



99-8831

Replaces: W705297-S300
**BLIND RIVET-FRONT BUMPER
 MOULDING & LIC. PLATE FRAME**
 Leg Retention Style
 Aluminum Rivet w/Aluminum Mandrel,
 1/4" Rivet, Flange: 11/16",
 G.R.: .187 - .375
 Ford Fusion/Milan/MKZ,
 Escape/Mariner 2008/, Fiesta 2011/
UNIT PACKAGE 10

LATEST NEW ITEMS FOR CHRYSLER & IMPORT PRODUCTS

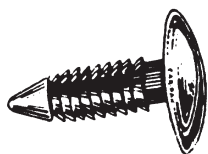

99-8816

Replaces: 6501916
**RETAINER-FRONT BUMPER,
FENDER & HEADLINER**
Plastic

Hole: M6.3, Head: 22MM, Stem Lgth:
28MM, P.R.: 4-22MM
Chrysler Mini Van & Pacifica '96/
UNIT PACKAGE 50



99-8829

Replaces: 6501948
RETAINER-FENDER & BUMPER
Plastic

Hole: M5.5, Head: 16MM,
Stem Lgth: 19MM, O/L: 21MM
Chrysler '89-'95
UNIT PACKAGE 50

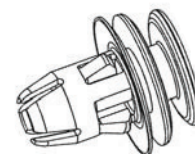

99-8852

Replaces: 68061648AA
RETAINER-TAIL LAMPS
Plastic

Hole: M9.5, Stem Lgth: 13MM,
O/L: 20MM, P.R.: 0.6-0.95MM,
Upper Hd: 15MM, Trim Thk: 2.5MM
Dodge Full Size Pick Ups 2009/
UNIT PACKAGE 15

NEW IMPORT

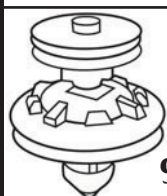

AUDI/VW

99-8859

Replaces: 6Q0-868-243
DRIVE RIVET-DOOR PANEL
Plastic

Hole: M8, Flange: 22.5MM,
O/L: 27MM, Stem Lgth: 11MM
Audi & Volkswagen 2004/
UNIT PACKAGE 15

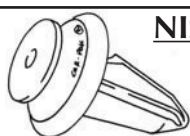

NISSAN

99-8857

Replaces: 84953-JA00A
RETAINER-DOOR PANEL
Plastic-Yellow

Hole: M8, Top Head: 12.7, O/L:
20MM, P.R.: 2.9 Max
Nissan Altima 2007/
UNIT PACKAGE 25

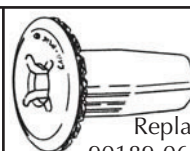

SUZUKI

99-8836

Replaces: 5480766,
90189-06084, 09148-05035
**GROMMET-TAIL LAMP, FENDER
APRON, LICENSE PLATE, DOOR PANEL**
Plastic w/Seal

Hole: M9, Flange: 18MM, O/L: 18MM,
P.R.: 0.8-1.0MM, Screw: M6
Chevrolet Equinox 2005/, Toyota Camry,
Previa '88-2001, Suzuki SX4 2007-2009
UNIT PACKAGE 10

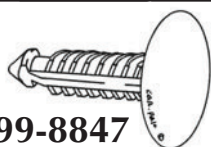

99-8847

Replaces: 5R3Z-54310D12-BAA,
G032-68-865A-00

**RETAINER-HOOD, COWL
INSULATORS & CARPET, Plastic-**
Textured

Hole: M6, Head: 20MM, O/L: 17MM,
Stem Lgth: 15MM, P.R.: 2.6-5.7
Ford Mustang 2005/,
Mazda 5, Miata, 626 & Protege '98/
UNIT PACKAGE 25



MAZDA

99-8805

Replaces: 3M8Z-17C432-A,
GK2A-50-798

GROMMET-COWL VENT, Plastic-w/Seal
Hole: 10x16MM, Flange: 15x27MM,
P.R.: 1.6MM, Screw: M5
Ford Fusion, Milan, Zepher & MKZ 2006/
Mazda 6 2003-2008
UNIT PACKAGE 5



99-8803

Replaces: 3M8Z-16K262-A, GJ6A-50-ES1
GROMMET-REAR BUMPER
Plastic-w/Seal

Hole: 17x20MM, Flange: 27x30MM,
O/L: 33.5MM, P.R.: 0.6-1.0MM
Ford Fusion, Lincoln MKS, Zepher/MKZ,
Mercury Milan 2006/
Mazda 6 2003/
UNIT PACKAGE 5

TOYOTA & LEXUS

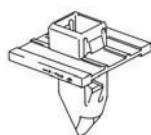

99-8818

Replaces: 61118-35010
RETAINER-FRONT FENDER MOULDING
Plastic

Hole: M9 (bottom), M9x10 (top) Flange:
18MM, Stem Lgth: 13MM, O/L: 21MM
Toyota FJ Cruiser 2007/
UNIT PACKAGE 10

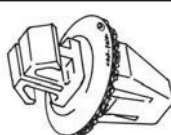

99-8811

Replaces: 75395-33030
**RETAINER-FENDER, DOOR
& QTR. PANELS**
Plastic-Pink, w/Seal

Hole: M9sq., Flange: 18MM,
O/L: 17.5MM
Lexus ES & RX300 '97/
UNIT PACKAGE 10



99-8817

Replaces: 90467-05063-C0
RIVET-SCREW TYPE, FRONT BUMPER
Plastic, Textured

Hole: M5, Flange: 11M,
Stem Lgth: 8MM
Toyota Celica & Corolla 2000/
Scion tC 2005/
UNIT PACKAGE 15

LATEST NEW ITEMS FOR G.M., FORD, CHRYSLER & IMPORT PRODUCTS

LATEST NEW ITEMS FOR IMPORT PRODUCTS

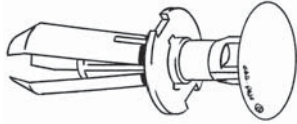

99-8841

Replaces: 90467-07188
DRIVE RIVET-FENDER, ROCKER & PICK UP BED MOULDINGS
 Plastic
 Hole: M7, Flange/Head: 15MM, Stem Lgth: 17MM
 Toyota Camry, 4Runner, Tundra, Tacoma 2002-2009
UNIT PACKAGE 25

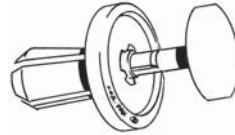

99-8842

Replaces: 90467-07214
DRIVE RIVET-ENGINE UNDER COVER
 Plastic
 Hole: M7, Flange: 20MM, Pin Hd: 14MM, Stem Lgth: 8.9MM, P.R.: 1.8-3.0MM
 Toyota Camry, Lexus & Scion 2007/
UNIT PACKAGE 15

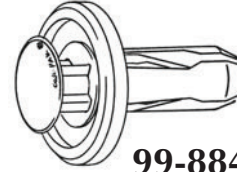

99-8843

Replaces: 90467-09227
DRIVE RIVET-BUMPER & ENGINE UNDER COVER
 Plastic, Black Body/Grey Pin
 Hole: M9, Flange: 22MM, Pin Hd: 15MM, Stem Lgth: 15MM, P.R.: 4.3-6.4MM
 Toyota 4Runner, RAV4 & Scion xB 2006/
UNIT PACKAGE 10

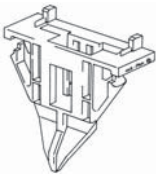

99-8819

Replaces: 61991-35010
RETAINER-UPPER FENDER PROTECTOR
 Passenger side, Plastic
 Slot: 7.5x23MM, Flange: 13x31MM, O/L: 33MM
 Toyota FJ Cruiser 2007/
UNIT PACKAGE 5

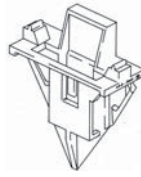

99-8820

Replaces: 61992-35010
RETAINER-UPPER FENDER PROTECTOR
 Driver side, Plastic
 Slot: 7.5x23MM, Flange: 13x31MM, O/L: 34MM
 Toyota FJ Cruiser 2007/
UNIT PACKAGE 5

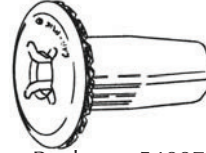

99-8836

Replaces: 5480766, 90189-06084, 09148-05035
GROMMET-TAIL LAMP, FENDER APRON, LICENSE PLATE, DOOR PANEL
 Plastic w/Seal
 Hole: M9, Flange: 18MM, O/L: 18MM, P.R.: 0.8-1.0MM, Screw: M6
 Chevrolet Equinox 2005/, Toyota Camry, Previa '88-2001, Suzuki SX4 2007-2009
UNIT PACKAGE 10



99-8840

Replaces: 75867-02010
RETAINER-ROCKER MOULDING
 Plastic
 Hole: M9, Flange: 18MM, Upper Hd: 13MM, Slot: 2.5MM, O/L: 16MM
 Toyota Corolla Matrix & 4Runner 2009/
UNIT PACKAGE 25



99-8844

Replaces: 65613-07010
NUT-COWL VENT & FENDER APRON
 Plastic
 Stud: M6, Flange: 22MM
 Toyota Venza 2009/
UNIT PACKAGE 15

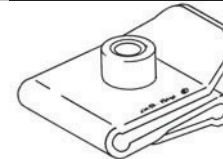

99-8835

Replaces: 53879-17020
U-NUT - FRONT BUMPER & FENDER APRON
 Plastic
 Screw: M4.8 (#10)
 Toyota Celica 2000-2005
 Lexus GS, IS, LS, SC 2001/
UNIT PACKAGE 10

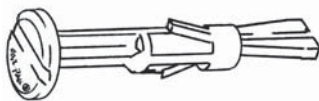

99-8833

Replaces: 47749-50090
PIN-FRONT BUMPER COVER
 Plastic, Use w/99-8834
 Head: 10MM, Stem Lgth: 24MM
 Lexus GS, IS, LS 2007/
UNIT PACKAGE 15



99-8834

Replaces: 53879-50020
CLIP-FRONT BUMPER
 Plastic, Use w/99-8833
 Lexus GS, IS, LS 2007/
UNIT PACKAGE 10

FUEL LINE



99-8860

Replaces: 4F1Z-9A317-AA
RETAINER-FUEL LINE
 Plastic
 5/16" Line
 Ford Taurus 2004/
UNIT PACKAGE 10

LATEST NEW ELECTRICAL REPAIR HARNESES

G.M.

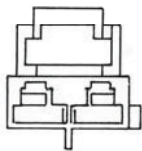
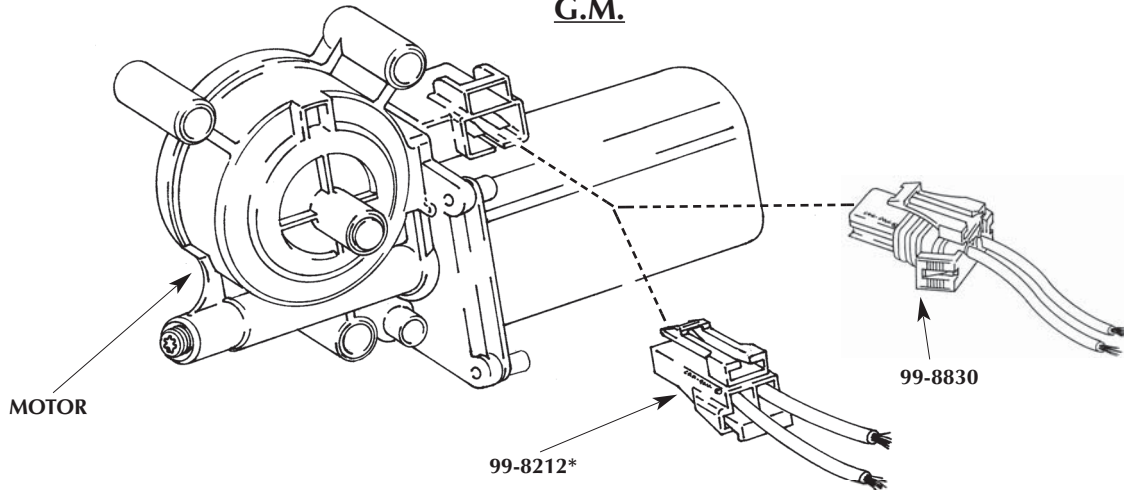

99-8212*

Replaces: 12101888, PT159
REPAIR HARNESS - WINDOW LIFT MOTORS
 Early Design Window Motors
 2-12 GA 8" GXL Leads
 G.M. '90-'95
 UNIT PACKAGE 1

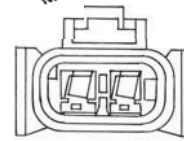

99-8830

Replaces: 88988609, PT2072
REPAIR HARNESS-WINDOW REGULATOR MOTOR, REAR VIEW MIRROR MOTOR, DOOR AJAR SWITCH
 Late Design Window Motors
 2-12 GA 8" LEADS
 G.M. '95/
 UNIT PACKAGE 1

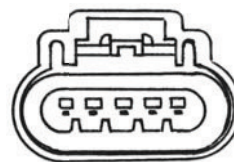
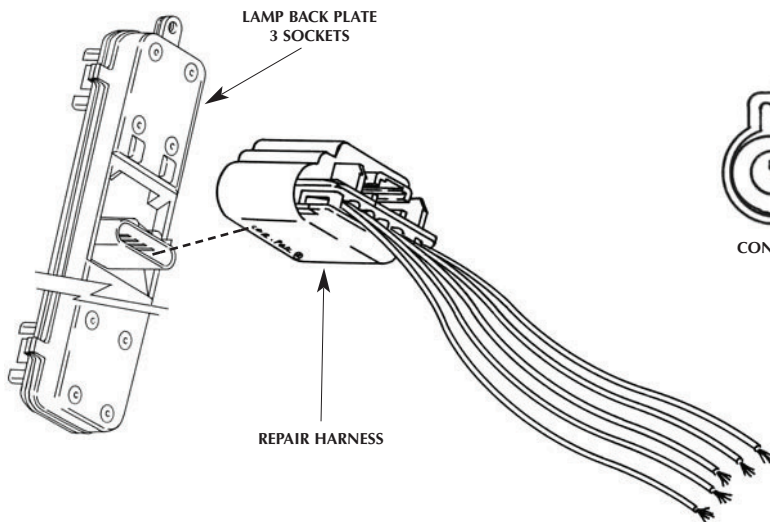

CONNECTOR FRONT VIEW

99-8858

Replaces: 88953146, PT1555
REPAIR HARNESS-COMBINATION LAMP BACK PLATE, #16532713
 5-20ga TXL 8" Leads
 G.M. S/T Trucks 2002-2009
 Saab 9-7 2005-2006
 Isuzu Acender 2003-2006
 UNIT PACKAGE 1

LATEST NEW ITEMS FOR IMORT PRODUCTS & ELECTRICAL REPAIR HARNESES FOR GENERAL MOTORS PRODUCTS

LATEST NEW FASTENERS & 'ANSWER' ASSORTMENTS

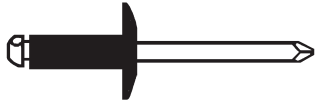

99-8813

BLIND RIVET-PIN GRIP

1/8" Rivet (M3.2), Flange: 3/8" (9.5MM),
G.R.: .125-.188 (3.2-4.8MM)
Aluminum Rivet/Mandrel
Same dimensions as 89-6631.
99-8813 is all aluminum,
89-6631 has a stainless steel mandrel
General purpose
UNIT PACKAGE 50



99-8814

CLAMP-FUEL INJECTION HOSE

Size No. 13
For Plastic, Silicone or Rubber
O.D. Range: 11.5-13.5MM
Rounded Edges & Unbroken Band
Prevents Damage to Hose
Clear Chromate Steel
General Purpose
UNIT PACKAGE 15



99-8815

CLAMP-FUEL INJECTION HOSE

Size No. 16
For Plastic, Silicone or Rubber
O.D. Range: 15.5-16.5MM
Rounded Edges & Unbroken Band
Prevents Damage to Hose
Clear Chromate Steel
General Purpose
UNIT PACKAGE 15

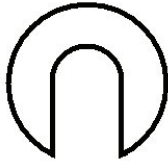

99-8827

SHIM - BODY

Thickness: 1/16",
O.D.: 15/16", Slot: 3/8"
Zinc Plate
UNIT PACKAGE 50

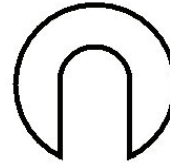

99-8828

SHIM - BODY

Thickness: 1/8",
O.D.: 15/16", Slot: 3/8"
Zinc Plate
UNIT PACKAGE 50



AN-927
12 Items
60 Total Pieces

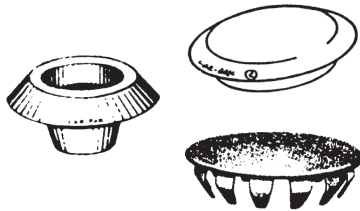

BOX SIZE: 8-1/4x4-1/2x1-3/8

AN927

ANSWER ASSORTMENT-HOLE PLUGS

Contains 5 each of:
76-4379, 84-5872, 92-7063, 95-7448, 95-7449, 95-7450,
95-7451, 95-7452, J03179, J03181, J03182, J03184
UNIT PACKAGE 1

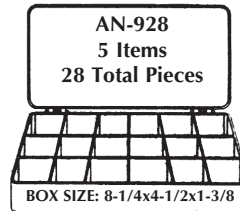

AN-928
5 Items
28 Total Pieces

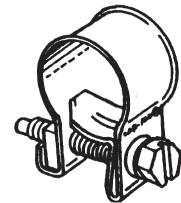

BOX SIZE: 8-1/4x4-1/2x1-3/8

AN928

**ANSWER ASSORTMENT-FUEL
INJECTION CLAMPS**

Contains: 5-89-6683, 8-89-6684,
5-99-8486, 5-99-8814, 5-99-8815
UNIT PACKAGE 1



AN-929
6 Items
48 Total Pieces

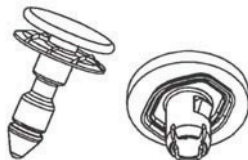

BOX SIZE: 8-1/4x4-1/2x1-3/8

AN929

**ANSWER ASSORTMENT-TRIM PANEL
PINS & GROMMETS**

Contains 4 each of: 99-8394, 99-8665,
99-8666, 99-8667, 99-8668, 99-8669
UNIT PACKAGE 1

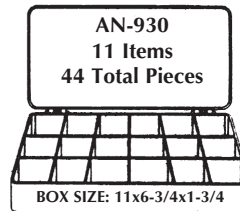

AN-930
11 Items
44 Total Pieces

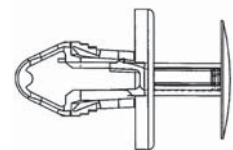

BOX SIZE: 11x6-3/4x1-3/4

AN930

ANSWER ASSORTMENT-ERGOLOK

DRIVE RIVETS, Contains 4 each of:
99-8552, 99-8578, 99-8579, 99-8580,
99-8695, 99-8696, 99-8697, 99-8698,
99-8699, 99-8700, 99-8701
UNIT PACKAGE 1



CAR-PAK
AUTOMOTIVE BODY MAINTENANCE PARTS
CATALOGUE SUPPLEMENT

June 2011

**ALL NEW PARTS
 JUST RELEASED PAGES 3-6**

**Plus New Items Previously Announced in
 Supplement No.1 November 2010**



**SUPPLEMENT NO. 2 TO
 CAR-PAK CATALOGUE 2010**



TABLE OF CONTENTS

••• *Latest New Items Not Previously Available* •••

••• *New Items Previously Announced* •••

Numerical Index	2	New Items For General Motors Products	7-8
All New Items For General Motors Products	3	New Items For Ford Products	8
All New Items For Ford Products	3	New Items For Chrysler Products	9
All New Items For Chrysler Products	3	New Items For Import Products	9-10
All New Items For Import Products	4	New Electrical Repair Harnesses	12
All New Electrical Repair Harnesses	5	New Fuel Line Clips for Ford Products	11
All New General Purpose Fasteners	6	All New General Purpose Fasteners	11
		All New 'Answer' Assortment	11



**USE THIS SUPPLEMENT ALONG WITH THE NEWLY COMBINED
CAR-PAK & JOBBERS SUPPLY CATALOG**

**THE CAR-PAK CATALOG CAN BE VIEWED AND DOWNLOADED
BY SECTION ON THE MAIN PAGE AT**

www.carpak.com

**OR AS A COMPLETE BOOKLET ON
THE 'REGISTERED USER' (DISTRIBUTORS ONLY) PAGE**

**NOT A REGISTERED DISTRIBUTOR YET?
REQUEST A LOGIN VIA EMAIL TO
*carpak@carpak.com***

NUMERICAL INDEX

PART #	PAGE #	PART #	PAGE #	PART #	PAGE #	PART #	PAGE #
99-8212	.12	99-8834	.10	99-8859	.9	99-8887	.6
99-8734	.5	99-8835	.10	99-8860	.11	99-8888	.6
99-8803	.8, 9	99-8836	.7, 9, 10	99-8861	.3	99-8889	.6
99-8805	.8, 9	99-8837	.7	99-8862	.7	99-8890	.6
99-8811	.9	99-8838	.7	99-8863	.7	99-8891	.6
99-8813	.11	99-8839	.7	99-8864	.5	99-8892	.6
99-8814	.11	99-8840	.10	99-8865	.3	99-8893	.6
99-8815	.11	99-8841	.10	99-8866	.3	99-8894	.6
99-8816	.9	99-8842	.10	99-8867	.3	99-8895	.6
99-8817	.9	99-8843	.10	99-8868	.4	99-8896	.6
99-8818	.9	99-8844	.10	99-8869	.4	99-8897	.6
99-8819	.10	99-8845	.7	99-8870	.4	99-8898	.6
99-8820	.10	99-8846	.5	99-8871	.4	99-8899	.6
99-8821	.8	99-8847	.8, 9	99-8873	.3	99-8900	.6
99-8822	.7	99-8848	.7	99-8874	.3	99-8901	.6
99-8823	.8	99-8849	.7	99-8876	.3	99-8902	.6
99-8824	.8	99-8850	.8	99-8877	.3	99-8903	.6
99-8825	.8	99-8851	.8	99-8879	.6	99-8904	.6
99-8826	.8	99-8852	.9	99-8880	.6	99-8907	.4
99-8827	.11	99-8853	.7	99-8881	.6	99-8911	.4
99-8828	.11	99-8854	.3	99-8882	.6	99-8912	.4
99-8829	.9	99-8855	.7	99-8883	.6	AN927	.11
99-8830	.12	99-8856	.4	99-8884	.6	AN928	.11
99-8831	.8	99-8857	.9	99-8885	.6	AN929	.11
99-8832	.8	99-8858	.12	99-8886	.6	AN930	.11
99-8833	.10						

LATEST NEW ITEMS FOR G.M., FORD & CHRYSLER PRODUCTS

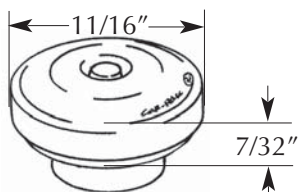

99-8854

Replaces: 9666748
ROLLER-WINDOW REGULATOR
 Plastic
 Formerly 78-4946
 G.M. '72-'96
UNIT PACKAGE 10

G.M.

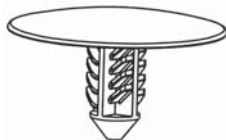

99-8874

Replaces: 11571159
RETAINER-HOOD INSULATION
 Plastic-Textured
 Hole: M7, Head: 30MM,
 Stem Lgth: 15MM, P.R.: 1.5-8MM
 Chevrolet Cruze 2011/
UNIT PACKAGE 25

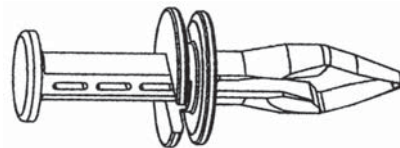

99-8861

Replaces: 10426555
RETAINER-FRONT BUMPER
 DEFLECTOR, Plastic
 Hole: M9.5-10, Flange: 24.5MM (top),
 23.4MM (lower), Stem Lgth: 35.5MM
 G.M. LaCrosse, Allure, Impala,
 Monte Carlo & Gr. Prix 2000/
UNIT PACKAGE 15

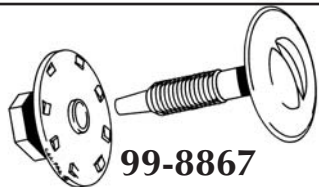

99-8867

Replaces: 11610747 & 11610748
SCREW & NUT-FRONT BUMPER AIR
 DEFLECTOR, Plastic
 Slotted Washer Head Screw
 Washer: 25MM, Stem Lgth: 25.7MM
 Hex Flange Nut
 Flange: 25MM, A/F: 13MM
 Cadillac SRX & Chevrolet Camaro 2010/
UNIT PACKAGE 15

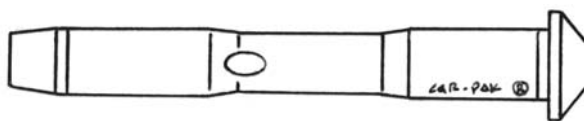

2 EACH



99-8873

Replaces: 89025546
KIT-DOOR HINGE REPAIR
 Contents: 2-Pins, 4-Bushings,
 2-Snap rings, 2-Grease Fittings
 G.M. Full Size Vans '96-2008
UNIT PACKAGE 1

FORD



99-8866

Replaces: W708633-S300
RETAINER-HOOD INSULATOR &
UNDER ENGINE SHIELD
 Plastic, Textured
 Hole: M6.3, Head: 31MM,
 Stem Lgth: 13MM, P.R. 1-7MM
 Ford Fusion, MKZ, Milan & Fiesta 2010/
UNIT PACKAGE 25



99-8865

Replaces: W711521-S300
RETAINER-DOOR PANEL
 Plastic, w/Seal
 Hole: M9, Upper Hd: 19.5MM,
 Trim Thk: 3MM, O/L: 26MM,
 Stem Lgth: 16MM, P.R. 0.6-1.0MM
 Ford Edge, Lincoln MKS & MKX 2007/
UNIT PACKAGE 15

CHRYSLER

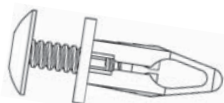

99-8876

Replaces: 55075139
RIVET-SCREW TYPE, DOOR TRIM
 Plastic
 Hole: M6, Flange: 11MM,
 Stem Lgth: 19MM, P.R.: 3-5MM,
 Pin Hd: 11MM, Drive: T20
 Dodge Ram Pick Up 2009/
UNIT PACKAGE 25

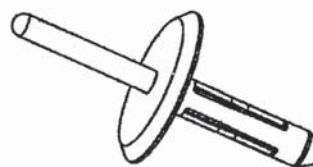

99-8877

Replaces: 6508444AA
BLIND RIVET-FENDER LINER
 Plastic
 Hole: M6.3-6.8, Flange: 26.5MM,
 Rivet Lgth: 25MM, P.R.: 4.0-6.0MM
 Dodge Dakota 2005/
UNIT PACKAGE 15

LATEST NEW ITEMS FOR G.M., FORD & CHRYSLER PRODUCTS

LATEST NEW ITEMS FOR IMPORT PRODUCTS

ACURA & HONDA



99-8856

Replaces: 90602-TA0-003
RETAINER-COWL VENT
 Plastic-Blue
 Hole: M6sq., Head: 10x14MM,
 O/L: 18MM, Slot: 2.5MM
 Honda Accord & Fit 2008/
 Acura TSX & ZDX 2009/
UNIT PACKAGE 10



99-8912

Replaces: 90682-SDA-A01
**GROMMET-REAR BUMPER &
 HEAD LAMP MOUNTING**, Plastic
 Hole: M9sq, Flange: 14MM Sq,
 O/L: 15MM Screw: M4.8 (#10)
 Honda Civic, CR-V,
 Pilot & Ridgeline 2006/
UNIT PACKAGE 15

MAZDA



99-8868

Replaces: BP4K-58-762
RETAINER-WEATHERSTRIP
 Plastic
 Hole: M4, Head: 9MM, Stem Lgth:
 7MM, P.R.: 3.5MM, O/L: 8.5MM
 Mazda 2007/
UNIT PACKAGE 25

NISSAN



99-8911

Replaces: 01553-08961, 90826FA000
**RETAINER-DOOR & HOOD
 WEATHERSTRIP**, Plastic, Textured
 Hole: M5, Head: 10MM,
 Stem Lgth: 8MM, P.R.: 3.4MM
 Infinity G35/37, I30/35 2007/, Nissan
 Altima, Murano 2003/, Subaru Forrester,
 Impreza, Legacy, Outback '95/
UNIT PACKAGE 25

SUBARU



99-8869

Replaces: 909140007
RIVET-DRIVE TYPE, BUMPERS
 Plastic
 Hole: M10, Flange: 21MM,
 Stem Lgth: 15MM, P.R.: 3-8MM
 Subaru 2003/
UNIT PACKAGE 15

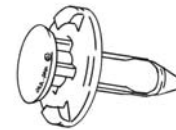

99-8870

Replaces: 909140051
RIVET-DRIVE TYPE, FRONT BUMPER
 Plastic
 Hole: M7, Flange: 20MM,
 Stem Lgth: 9MM, O/L: 21MM,
 Pin Head Dia: 12MM
 Subaru Outback & Tribeca 2005/
UNIT PACKAGE 15



99-8871

Replaces: 909130074
RETAINER-HOOD INSULATOR
 Plastic-Textured
 Hole: M7, Head: 30MM,
 Stem Lgth: 13MM, P.R.: 3-11MM
 Subaru 2002/
UNIT PACKAGE 15



99-8911

Replaces: 01553-08961, 90826FA000
**RETAINER-DOOR & HOOD
 WEATHERSTRIP**, Plastic, Textured
 Hole: M5, Head: 10MM,
 Stem Lgth: 8MM, P.R.: 3.4MM
 Infinity G35/37, I30/35 2007/, Nissan
 Altima, Murano 2003/, Subaru Forrester,
 Impreza, Legacy, Outback '95/
UNIT PACKAGE 25

TOYOTA



99-8907

Replaces: 90269-03064
BLIND RIVET-DOOR MOULDING
 Aluminum Rivet/Aluminum Mandrel
 M3.2 (.125) Rivet, Black Flange: 9.5MM
 (.375), G.R.: 1.6-3.2MM (.063-.125),
 Rivet Lgth: M6.3 (.250)
 Lexus ES300/330 2002-2006
 Toyota Avalon 2000-2004
UNIT PACKAGE 15

LATEST NEW ELECTRICAL REPAIR HARNESSSES FOR G.M., FORD & CHRYSLER

LATEST NEW ITEMS FOR IMORT PRODUCTS & ELECTRICAL REPAIR HARNESSSES FOR G.M., FORD & CHRYSLER PRODUCTS

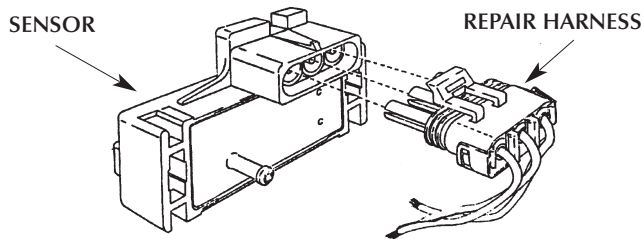

99-8734

Replaces: 12085502, PT123, 88862232, PT2313
REPAIR HARNESS-MANIFOLD ABSOLUTE PRESSURE
 (M.A.P.) Sensor # 16137039, 12569240
 Formerly 91-6990
 3-18 Ga. (GXL) Leads 8" Length
 G.M. Vehicles '82/
UNIT PACKAGE 1

99-8846

Replaces: 3U2Z-14S411-ZEA, WPT-688
REPAIR HARNESS-BLOWER RESISTOR
 Resistor #3F2Z-18591-AA, 4W7Z-19A706-A
 4-12GA TXL 8" Leads
 Ford Cars, Lt. & Med Duty Trucks 2004/
UNIT PACKAGE 1

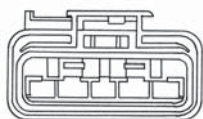
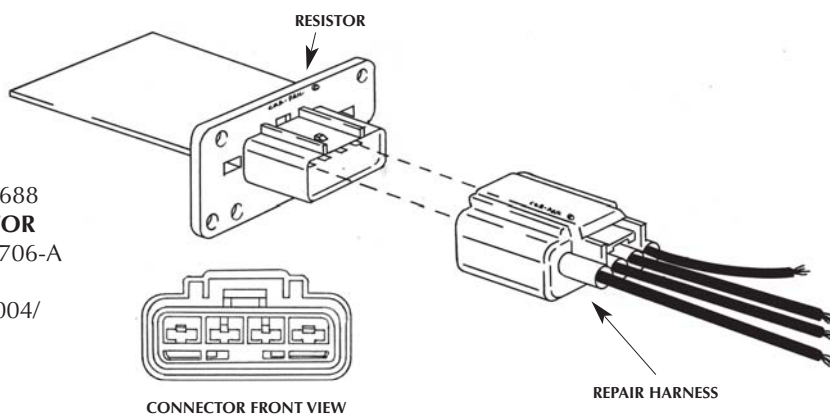

FRONT VIEW

99-8864

Replaces: 5017124AB
REPAIR HARNESS, KIT-BLOWER RESISTOR
 Resistor #5061575AA, 5061094AB,
 5166541AB, 5174618AA, 5183153AA
 Contains: 1-Connector,
 5-16ga & 5-12ga TXL 8" leads
 Chrysler, Dodge & Jeep 2001/
UNIT PACKAGE 1

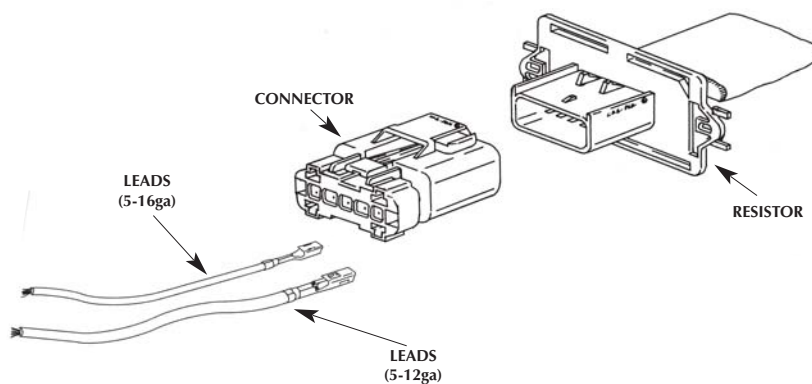

SMALL HEX HEAD FLANGE BOLTS - J.I.S. B1189, CLASS 10.9

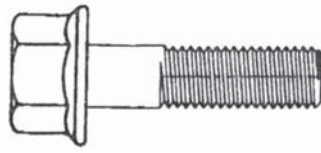

ZINC FINISH

CAR-PAK #	THREAD SIZE	LENGTH	HEX	FLANGE	UNIT PKG	CAR-PAK #	THREAD SIZE	LENGTH	HEX	FLANGE	UNIT PKG
99-8879	M6-1.0	12MM	10MM	14MM	50	99-8891	M8-1.25	30MM	12MM	17.5MM	15
99-8880	M6-1.0	16MM	10MM	14MM	50	99-8892	M8-1.25	35MM	12MM	17.5MM	15
99-8881	M6-1.0	20MM	10MM	14MM	50	99-8893	M8-1.25	40MM	12MM	17.5MM	15
99-8882	M6-1.0	25MM	10MM	14MM	25	99-8894	M8-1.25	45MM	12MM	17.5MM	15
99-8883	M6-1.0	30MM	10MM	14MM	25	99-8895	M10-1.25	16MM	14MM	20MM	10
99-8884	M6-1.0	35MM	10MM	14MM	25	99-8896	M10-1.25	20MM	14MM	20MM	10
99-8885	M6-1.0	40MM	10MM	14MM	25	99-8897	M10-1.25	25MM	14MM	20MM	10
99-8886	M6-1.0	45MM	10MM	14MM	15	99-8898	M10-1.25	30MM	14MM	20MM	10
99-8887	M8-1.25	12MM	12MM	17.5MM	25	99-8899	M10-1.25	35MM	14MM	20MM	10
99-8888	M8-1.25	16MM	12MM	17.5MM	15	99-8900	M10-1.25	40MM	14MM	20MM	10
99-8889	M8-1.25	20MM	12MM	17.5MM	15	99-8901	M10-1.25	45MM	14MM	20MM	10
99-8890	M8-1.25	25MM	12MM	17.5MM	15						

SERRATED FLANGE HEX NUTS - J.I.S. B1190, CASE HARDENED



ZINC FINISH

CAR-PAK #	THREAD SIZE	FLANGE DIA.	A/F	UNIT PKG
99-8902	M6-1.0	14MM	10MM	50
99-8903	M8-1.25	17MM	12MM	50
99-8904	M10-1.25	19MM	14MM	25

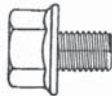

99-8879

SCREW-LICENSE PLATE,
HEX FLANGE HEAD
M6-1.0 x 12MM, Flange: 14MM,
A/F: 10MM, Grade 10.9, Finish Zinc
UNIT PACKAGE 50

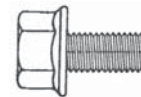

99-8880

SCREW-LICENSE PLATE,
HEX FLANGE HEAD
M6-1.0 x 16MM, Flange: 14MM,
A/F: 10MM, Grade 10.9, Finish Zinc
UNIT PACKAGE 50

NEW ITEMS FOR G.M. PRODUCTS

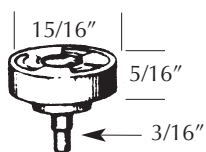
**99-8845**

Replaces: 3069189
ROLLER-WINDOW REGULATOR TO CHANNEL
 Formerly 65-1093
 G.M. '65/, S/T Truck '94/
 G.M. 'J' Body '82 / '91, Ford '71
UNIT PACKAGE 5

**99-8863**

Replaces: 5482087
CLIP-GRILLE MOUNTING
 Plastic
 G.M. Equinox 2005/
UNIT PACKAGE 15

**99-8848**

Replaces: 13252119
RETAINER-DOOR PANEL
 Plastic-Green
 Hole: M7.4, Top Hd: 15MM,
 O/L: 20MM, Slot: 2.6MM,
 Stem Lgth: 16MM, P.R.: 1.75-2.0MM
 G.M. Equinox, Terrain,
 Cadillac SRX 2010/ & Buick Regal 2011
UNIT PACKAGE 25

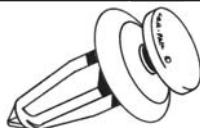
**99-8849**

Replaces: 13252118
RETAINER-DOOR PANEL
 Plastic-Blue
 Hole: M7.4, Top Hd: 13MM,
 O/L: 20MM, Slot: 2.6MM,
 Stem Lgth: 13MM, P.R.: 0.7-0.9MM
 G.M. Equinox, Terrain &
 Cadillac SRX 2010/
UNIT PACKAGE 25

**99-8853**

Replaces: 11561654
RETAINER-COWL,
WINDSHIELD & DOOR PILLAR,
INTERIOR TRIM PANELS, Plastic
 Hole: M8, Upper Hd: 13MM,
 O/L: 22MM, Trim Thk: 2.5MM
 G.M. Cars & Trucks 2006/
 Saturn 2007-2009, Hummer 2009
UNIT PACKAGE 15

**99-8862**

Replaces: 94530385
RETAINER-LOWER DOOR MOULDING
 Plastic w/Seal
 Hole: 7x8MM, Sec Hole: 5x8MM,
 Top Head: 12x14MM,
 Stem Lgth: 13MM, O/L: 19MM
 Saturn Vue 2008/
UNIT PACKAGE 10

**99-8822**

Replaces: 94530742
RETAINER-FENDER, WHEEL, SIDE & BUMPER MOULDINGS
 Plastic, w/Seal
 Hole: M8, Top Hd: 11x15MM, O/L: 15MM, Stem Lgth: 10MM
 Saturn Vue 2008-2009
UNIT PACKAGE 15

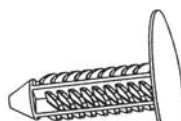
**99-8837**

Replaces: 15802005
RETAINER-FENDER & HEADLINER
 Plastic, Textured
 Hole: M7, Head: 25.4MM, Stem Lgth: 26MM, O/L: 29MM, P.R.: 1-13MM
 Buick Enclave, Chevrolet Traverse & Camaro, GMC Acadia & Saturn Outlook 2008/
UNIT PACKAGE 25

**99-8838**

Replaces: 11562250, 11571175
RETAINER-ROCKER MOULDING & FRONT SIGNAL LAMP
 Plastic w/Seal
 Hole: M9, Head: 12x20MM,
 O/L: 16MM, Stem Lgth: 11MM,
 Slot: 2.5MM, P.R. 0.08
 G.M. Enclave, Equinox, Traverse, Acadia, Terrain, 2005/, Cadillac SRX 2010, Saturn Outlook & Relay 2005/
UNIT PACKAGE 15

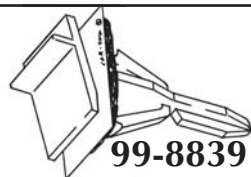
**99-8839**

Replaces: 25775903
RETAINER-ROCKER MOULDING
 Plastic w/Seal
 Hole: M9, Head: 12x16MM,
 O/L: 35MM, Stem Lgth: 24MM,
 P.R.: 0.75
 G.M. Enclave, Traverse, Acadia & Saturn Outlook 2007/
UNIT PACKAGE 10

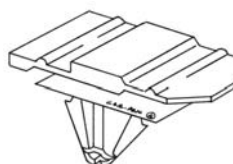
**99-8855**

Replaces: 25922739
RETAINER-ROCKER MOULDING
 Plastic-Green
 Hole: M9, Top Hd.: 12x29MM
 G.M. Enclave, Traverse & Acadia 2009/
UNIT PACKAGE 25

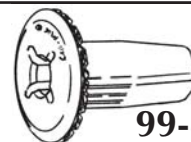
**99-8836**

Replaces: 5480766, 90189-06084, 09148-05035
GROMMET-TAIL LAMP, FENDER APRON, LICENSE PLATE, DOOR PANEL
 Plastic w/Seal
 Hole: M9sq., Flange: 18MM,
 O/L: 18MM, P.R.: 0.8-1.0MM, Screw: M6
 Chevrolet Equinox 2005/, Toyota Camry, Previa '88-2001, Suzuki SX4 2007-2009
UNIT PACKAGE 10

 SECTION 2: PREVIOUSLY ANNOUNCED ITEMS
 LATEST NEW J.I.S. BOLT & NUTS & NEW ITEMS FOR GENERAL MOTORS PRODUCTS

LATEST NEW ITEMS FOR G.M. & FORD PRODUCTS



99-8821

Replaces: 25910528
SCREW-LICENSE PLATE
 M6-1.0 x 12MM
 Finish: Silver Dacromet
 Cadillac SRX & General Purpose
UNIT PACKAGE 50



99-8823

Replaces: 11588441
**PUSH NUT-FENDER, QTR PANEL
 & GRILLE**
 For Non-Threaded Studs
 M6 X 24MM
 Zinc Finish
 GM Cars & Trucks 2002/, & Hummer
UNIT PACKAGE 50



99-8824

Replaces: 11588308
**BLIND RIVET-NYLON, FRONT GRILLE,
 BUMPER & ROCKER MOULDING**
 Hole: M5, Flange: 9MM, G.R.: 3-6MM
 Buick Lucerne, Cadillac DTS/CTS 2006/
 & G.M. 'U' Body Van '97-2005
UNIT PACKAGE 25



99-8825

Replaces: 15856741
BLIND RIVET-REAR BUMPER COVER
 Multi-Grip Type
 Aluminum Rivet/Steel Mandrel
 1/4" Rivet, 1/2" Flange, 0.080-0.350 G.R.,
 25/32" Rivet Length
 Buick Lucerne 2006/ & General Purpose
UNIT PACKAGE 15

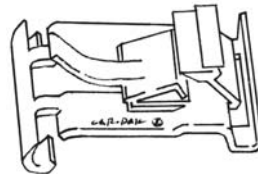

99-8832

Not Supplied by O.E.
RETAINER-BELT MOULDING
 Plastic
 Ford Taurus 2010/
UNIT PACKAGE 10

FORD



99-8805

Replaces: 3M8Z-17C432-A,
 GK2A-50-798
GROMMET-COWL VENT, Plastic-w/Seal
 Hole: 10x16MM, Flange: 15x27MM,
 P.R.: 1.6MM, Screw: M5
 Ford Fusion, Milan, Zepher & MKZ 2006/
 Mazda 6 2003-2008
UNIT PACKAGE 5

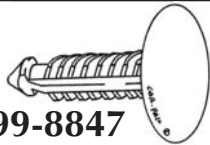

99-8847

Replaces: 5R3Z-54310D12-BAA,
 G032-68-865A-00
**RETAINER-HOOD, COWL
 INSULATORS & CARPET, Plastic-
 Textured**
 Hole: M6, Head: 20MM, O/L: 17MM,
 Stem Lgth: 15MM, P.R.: 2.6-5.7
 Ford Mustang 2005/
 Mazda 5, Miata, 626 & Protoge '98/
UNIT PACKAGE 25



99-8803

Replaces: 3M8Z-16K262-A, GJ6A-50-ES1
GROMMET-REAR BUMPER
 Plastic-w/Seal
 Hole: 17x20MM, Flange: 27x30MM,
 O/L: 33.5MM, P.R.: 0.6-1.0MM
 Ford Fusion, Lincoln MKS, Zepher/MKZ,
 Mercury Milan 2006/
 Mazda 6 2003/
UNIT PACKAGE 5

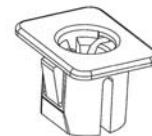

99-8850

Replaces: W711079-S300
GROMMET-TAIL LAMP
 Stud Retaining, Plastic
 Hole: 10x15MM,
 Flange: 13x17MM, O/L: 11MM
 Ford Explorer/Mountaineer
 & Pick Ups 2006/
UNIT PACKAGE 25

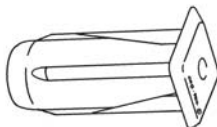

99-8851

Replaces: W708580-S300
**GROMMET-MARKER & TAIL LAMPS,
 BUMPERS**
 Plastic, Closed End
 Hole: M7.7, Flange: 12MM,
 O/L: 19MM, P.R.: 0.8MM
 Ford Fusion/Milan/MKZ,
 Expedition/Navigator 2006/
UNIT PACKAGE 25



99-8826

Replaces: W711858-S300
**RETAINER-HOOD & DOOR
 WEATHERSTRIP**
 Hole: M5, Top Hd: 5x15MM,
 O/L: 12.5MM, P.R.: 0.74 & 2.0MM
 Ford Edge, Flex, MKT & MKX 2007/
UNIT PACKAGE 100



99-8831

Replaces: W705297-S300
**BLIND RIVET-FRONT BUMPER
 MOULDING & LIC. PLATE FRAME**
 Leg Retention Style
 Aluminum Rivet w/Aluminum Mandrel,
 1/4" Rivet, Flange: 11/16",
 G.R.: .187 - .375
 Ford Fusion/Milan/MKZ,
 Escape/Mariner 2008/, Fiesta 2011/
UNIT PACKAGE 10

NEW ITEMS FOR CHRYSLER & IMPORT PRODUCTS PRODUCTS

CHRYSLER

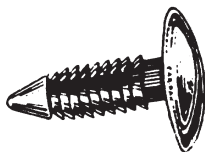

99-8816

Replaces: 6501916

**RETAINER-FRONT BUMPER,
FENDER & HEADLINER**
Plastic

Hole: M6.3, Head: 22MM, Stem Lgth:
28MM, P.R.: 4-22MM
Chrysler Mini Van & Pacifica '96/
UNIT PACKAGE 50

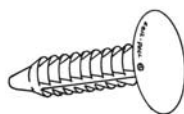

99-8829

Replaces: 6501948

RETAINER-FENDER & BUMPER
Plastic

Hole: M5.5, Head: 16MM,
Stem Lgth: 19MM, O/L: 21MM
Chrysler '89-'95
UNIT PACKAGE 50

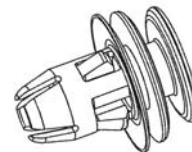

99-8852

Replaces: 68061648AA

RETAINER-TAIL LAMPS
Plastic

Hole: M9.5, Stem Lgth: 13MM,
O/L: 20MM, P.R.: 0.6-0.95MM,
Upper Hd: 15MM, Trim Thk: 2.5MM
Dodge Full Size Pick Ups 2009/
UNIT PACKAGE 15

AUDI/VW

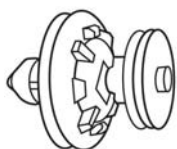

99-8859

Replaces: 6Q0-868-243

DRIVE RIVET-DOOR PANEL
Plastic

Hole: M8, Flange: 22.5MM,
O/L: 27MM, Stem Lgth: 11MM
Audi & Volkswagen 2004/
UNIT PACKAGE 15

NISSAN

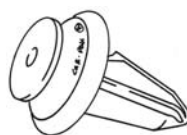

99-8857

Replaces: 84953-JA00A

RETAINER-DOOR PANEL
Plastic-Yellow

Hole: M8, Top Head: 12.7, O/L:
20MM, P.R.: 2.9 Max
Nissan Altima 2007/
UNIT PACKAGE 25

SUZUKI

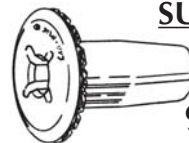

99-8836

Replaces: 5480766,

90189-06084, 09148-05035

**GROMMET-TAIL LAMP, FENDER
APRON, LICENSE PLATE, DOOR PANEL**
Plastic w/Seal

Hole: M9, Flange: 18MM, O/L: 18MM,
P.R.: 0.8-1.0MM, Screw: M6
Chevrolet Equinox 2005/, Toyota Camry,
Previa '88-2001, Suzuki SX4 2007-2009
UNIT PACKAGE 10

MAZDA

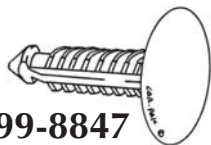

99-8847

Replaces: 5R3Z-54310D12-BAA,
G032-68-865A-00

**RETAINER-HOOD, COWL
INSULATORS & CARPET, Plastic-**
Textured

Hole: M6, Head: 20MM, O/L: 17MM,
Stem Lgth: 15MM, P.R.: 2.6-5.7
Ford Mustang 2005/,
Mazda 5, Miata, 626 & Protoge '98/
UNIT PACKAGE 25



99-8805

Replaces: 3M8Z-17C432-A,
GK2A-50-798

GROMMET-COWL VENT, Plastic-w/Seal

Hole: 10x16MM, Flange: 15x27MM,
P.R.: 1.6MM, Screw: M5
Ford Fusion, Milan, Zepher & MKZ 2006/
Mazda 6 2003-2008
UNIT PACKAGE 5



99-8803

Replaces: 3M8Z-16K262-A, GJ6A-50-ES1

GROMMET-REAR BUMPER
Plastic-w/Seal

Hole: 17x20MM, Flange: 27x30MM,
O/L: 33.5MM, P.R.: 0.6-1.0MM
Ford Fusion, Lincoln MKS, Zepher/MKZ,
Mercury Milan 2006/
Mazda 6 2003/
UNIT PACKAGE 5

TOYOTA & LEXUS

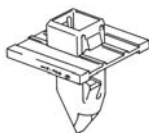

99-8818

Replaces: 61118-35010

RETAINER-FRONT FENDER MOULDING
Plastic

Hole: M9 (bottom), M9x10 (top) Flange:
18MM, Stem Lgth: 13MM, O/L: 21MM
Toyota FJ Cruiser 2007/
UNIT PACKAGE 10

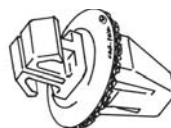

99-8811

Replaces: 75395-33030

**RETAINER-FENDER, DOOR
& QTR. PANELS**
Plastic-Pink, w/Seal

Hole: M9sq., Flange: 18MM,
O/L: 17.5MM
Lexus ES & RX300 '97/
UNIT PACKAGE 10



99-8817

Replaces: 90467-05063-C0

RIVET-SCREW TYPE, FRONT BUMPER
Plastic, Textured

Hole: M5, Flange: 11MM,
Stem Lgth: 8MM
Toyota Celica & Corolla 2000/
Scion tC 2005/
UNIT PACKAGE 15

NEW ITEMS FOR G.M., FORD, CHRYSLER & IMPORT PRODUCTS

NEW ITEMS FOR IMPORT PRODUCTS

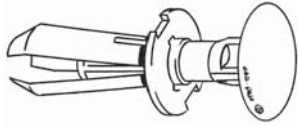

99-8841

Replaces: 90467-07188
DRIVE RIVET-FENDER, ROCKER & PICK UP BED MOULDINGS
 Plastic
 Hole: M7, Flange/Head: 15MM, Stem Lgth: 17MM
 Toyota Camry, 4Runner, Tundra, Tacoma 2002-2009
UNIT PACKAGE 25

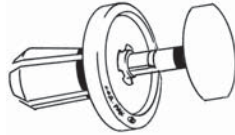

99-8842

Replaces: 90467-07214
DRIVE RIVET-ENGINE UNDER COVER
 Plastic
 Hole: M7, Flange: 20MM, Pin Hd: 14MM, Stem Lgth: 8.9MM, P.R.: 1.8-3.0MM
 Toyota Camry, Lexus & Scion 2007/
UNIT PACKAGE 15

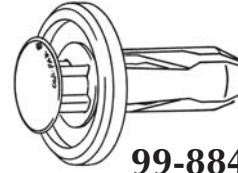

99-8843

Replaces: 90467-09227
DRIVE RIVET-BUMPER & ENGINE UNDER COVER
 Plastic, Black Body/Grey Pin
 Hole: M9, Flange: 22MM, Pin Hd: 15MM, Stem Lgth: 15MM, P.R.: 4.3-6.4MM
 Toyota 4Runner, RAV4 & Scion xB 2006/
UNIT PACKAGE 10

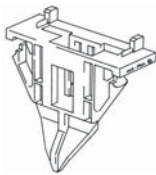

99-8819

Replaces: 61991-35010
RETAINER-UPPER FENDER PROTECTOR
 Passenger side, Plastic
 Slot: 7.5x23MM, Flange: 13x31MM, O/L: 33MM
 Toyota FJ Cruiser 2007/
UNIT PACKAGE 5

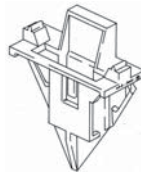

99-8820

Replaces: 61992-35010
RETAINER-UPPER FENDER PROTECTOR
 Driver side, Plastic
 Slot: 7.5x23MM, Flange: 13x31MM, O/L: 34MM
 Toyota FJ Cruiser 2007/
UNIT PACKAGE 5

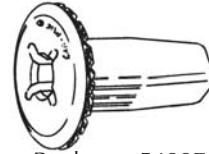

99-8836

Replaces: 5480766, 90189-06084, 09148-05035
GROMMET-TAIL LAMP, FENDER APRON, LICENSE PLATE, DOOR PANEL
 Plastic w/Seal
 Hole: M9, Flange: 18MM, O/L: 18MM, P.R.: 0.8-1.0MM, Screw: M6
 Chevrolet Equinox 2005/, Toyota Camry, Previa '88-2001, Suzuki SX4 2007-2009
UNIT PACKAGE 10



99-8840

Replaces: 75867-02010
RETAINER-ROCKER MOULDING
 Plastic
 Hole: M9, Flange: 18MM, Upper Hd: 13MM, Slot: 2.5MM, O/L: 16MM
 Toyota Corolla Matrix & 4Runner 2009/
UNIT PACKAGE 25



99-8844

Replaces: 65613-07010
NUT-COWL VENT & FENDER APRON
 Plastic
 Stud: M6, Flange: 22MM
 Toyota Venza 2009/
UNIT PACKAGE 15

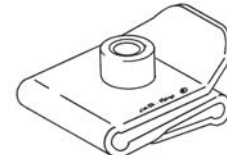

99-8835

Replaces: 53879-17020
U-NUT - FRONT BUMPER & FENDER APRON
 Plastic
 Screw: M4.8 (#10)
 Toyota Celica 2000-2005
 Lexus GS, IS, LS, SC 2001/
UNIT PACKAGE 10

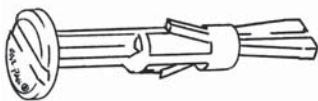

99-8833

Replaces: 47749-50090
PIN-FRONT BUMPER COVER
 Plastic, **Use w/99-8834**
 Head: 10MM, Stem Lgth: 24MM
 Lexus GS, IS, LS 2007/
UNIT PACKAGE 15

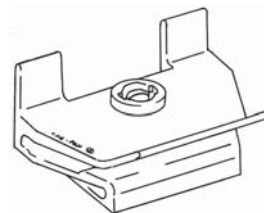

99-8834

Replaces: 53879-50020
CLIP-FRONT BUMPER
 Plastic, **Use w/99-8833**
 Lexus GS, IS, LS 2007/
UNIT PACKAGE 10

NEW FASTENER ITEMS & 'ANSWER' ASSORTMENTS



99-8813

BLIND RIVET-PIN GRIP

1/8" Rivet (M3.2), Flange: 3/8" (9.5MM),
G.R.: .125-.188 (3.2-4.8MM)

Aluminum Rivet/Mandrel

Same dimensions as 89-6631.

99-8813 is all aluminum,

89-6631 has a stainless steel mandrel

General purpose

UNIT PACKAGE 50



99-8827

SHIM - BODY

Thickness: 1/16",

O.D.: 15/16", Slot: 3/8"

Zinc Plate

UNIT PACKAGE 50

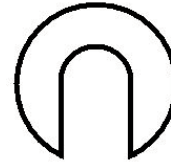

99-8828

SHIM - BODY

Thickness: 1/8",

O.D.: 15/16", Slot: 3/8"

Zinc Plate

UNIT PACKAGE 50

FUEL LINE



99-8860

Replaces: 4F1Z-9A317-AA

RETAINER-FUEL LINE

Plastic

5/16" Line

Ford Taurus 2004/

UNIT PACKAGE 10



99-8814

CLAMP-FUEL INJECTION HOSE

Size No. 13

For Plastic, Silicone or Rubber

O.D. Range: 11.5-13.5MM

Rounded Edges & Unbroken Band

Prevents Damage to Hose

Clear Chromate Steel

General Purpose

UNIT PACKAGE 15



99-8815

CLAMP-FUEL INJECTION HOSE

Size No. 16

For Plastic, Silicone or Rubber

O.D. Range: 15.5-16.5MM

Rounded Edges & Unbroken Band

Prevents Damage to Hose

Clear Chromate Steel

General Purpose

UNIT PACKAGE 15



AN927

ANSWER ASSORTMENT-HOLE PLUGS

Contains 5 each of:

76-4379, 84-5872, 92-7063, 95-7448, 95-7449, 95-7450,
95-7451, 95-7452, J03179, J03181, J03182, J03184

UNIT PACKAGE 1



AN928

ANSWER ASSORTMENT-FUEL INJECTION CLAMPS

Contains: 5-89-6683, 8-89-6684,
5-99-8486, 5-99-8814, 5-99-8815

UNIT PACKAGE 1

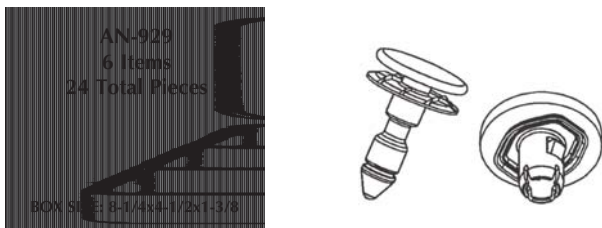

AN929

ANSWER ASSORTMENT-TRIM PANEL PINS & GROMMETS

Contains 4 each of: 99-8394, 99-8665,
99-8666, 99-8667, 99-8668, 99-8669

UNIT PACKAGE 1



AN930

ANSWER ASSORTMENT-ERGOLOK

DRIVE RIVETS, Contains 4 each of:
99-8552, 99-8578, 99-8579, 99-8580,
99-8695, 99-8696, 99-8697, 99-8698,
99-8699, 99-8700, 99-8701

UNIT PACKAGE 1

NEW FASTENER, MISCELLANEOUS ITEMS & 'ANSWER' ASSORTMENTS

NEW ELECTRICAL REPAIR HARNESES FOR G.M. PRODUCTS

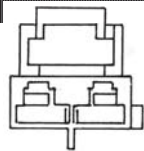
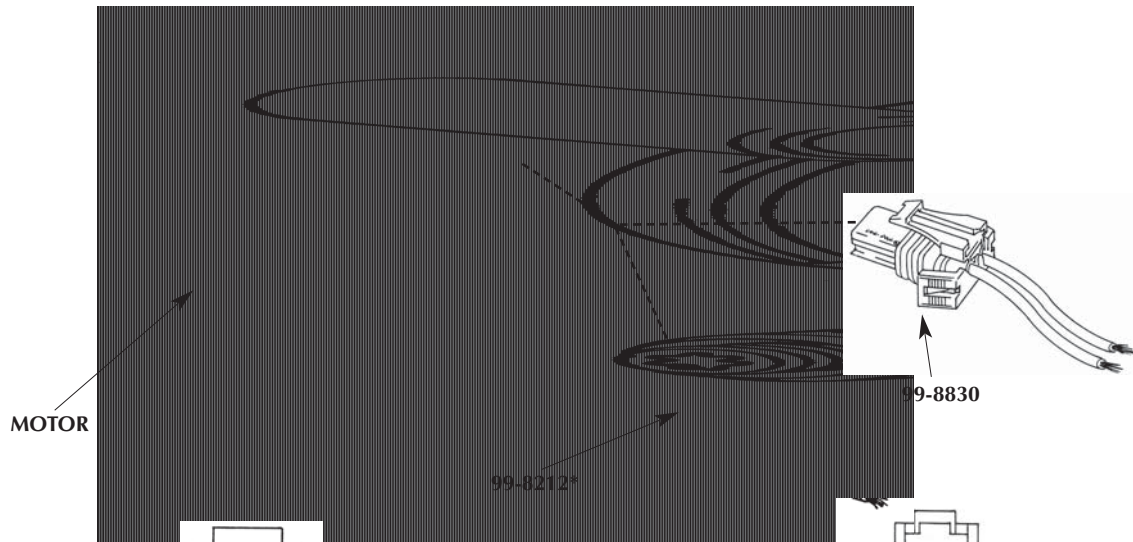

99-8212*

Replaces: 12101888, PT159
REPAIR HARNESS - WINDOW LIFT MOTORS
 Early Design Window Motors
 2-12 GA 8" GXL Leads
 G.M. '90-'95
 UNIT PACKAGE 1

G.M.

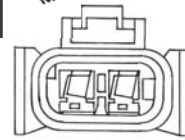

99-8830

Replaces: 88988609, PT2072
**REPAIR HARNESS-WINDOW REGULATOR MOTOR,
 REAR VIEW MIRROR MOTOR, DOOR AJAR SWITCH**
 Late Design Window Motors
 2-12 GA 8" LEADS
 G.M. '95/
 UNIT PACKAGE 1

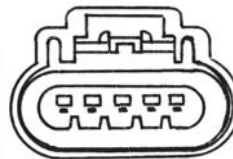
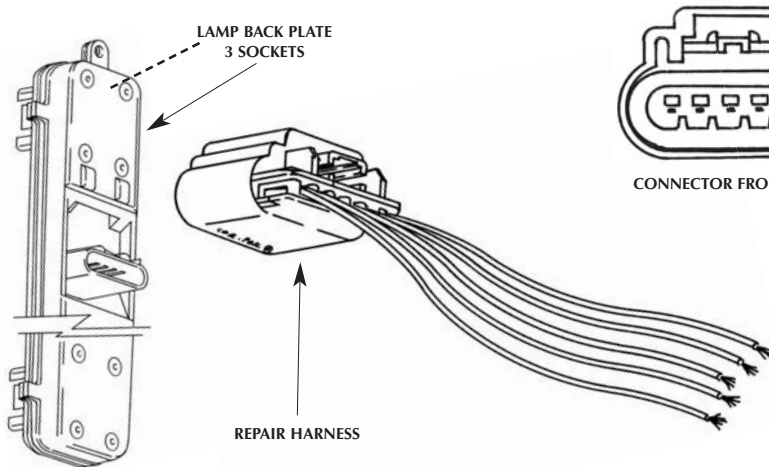

CONNECTOR FRONT VIEW

99-8858

Replaces: 88953146, PT1555
**REPAIR HARNESS-COMBINATION
 LAMP BACK PLATE, #16532713**
 5-20ga TXL 8" Leads
 G.M. S/T Trucks 2002-2009
 Saab 9-7 2005-2006
 Isuzu Acender 2003-2006
 UNIT PACKAGE 1