

# HOT

"Since 1916"

**Au-ve-co**<sup>®</sup>  
PRODUCTS

HNI-303 1/13/12

## New Item Bulletin

## Items Available For Immediate Shipment

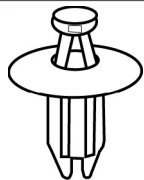

**21477**

(Honda: 91550-S50-000ZK)  
Gray Nylon

Push-Type Retainer  
Head Diameter: 16mm  
Stem Length: 14mm  
Fits Into 7mm Hole

Honda Civic, CR-V, Element & Insight  
2006 - 2000

UNIT PACKAGE: 15



**21458**

(Honda: 91567-S3M-000)  
Black Nylon

Weatherstrip Retainer  
Head Diameter: 10mm  
Stem Diameter: 5.5mm  
Stem Length: 7mm

Honda Accord, Civic & Odyssey  
2011 - 03

UNIT PACKAGE: 25

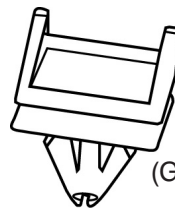

**21504**

(GM: 10445899)  
Black Nylon

Door Moulding Clip  
Top Head Size: 14mm x 20mm  
Bottom Head Size: 15.5mm x 20mm  
Stem Length: 14mm  
Fits Into 9mm Hole

Chevrolet Venture, Olds Silhouette,  
Pontiac Montana & Trans Sport 2005 - 97  
and Buick Enclave, Chevrolet Traverse &  
GMC Acadia 2008 - On

UNIT PACKAGE: 15



**21506**

Not Available From O.E.M.  
Black & White Nylon

Windshield Moulding Clip With Sealer

Top Head Size: 13mm x 13.5mm  
Bottom Head Size: 12mm x 14mm  
Stem Length: 9mm

Ford Explorer 2011 - On

UNIT PACKAGE: 10

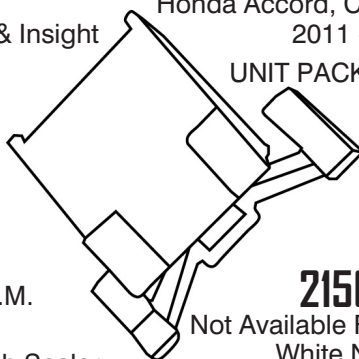

**21507**

Not Available From O.E.M.  
White Nylon

Belt Moulding Clip  
Width: 25mm  
Length: 36mm

Overall Height: 27mm  
Ford Edge 2009 - On

UNIT PACKAGE: 15

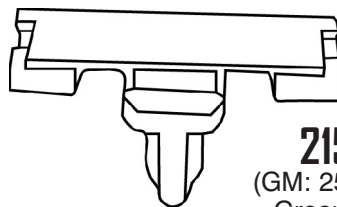

**21503**

(GM: 25744385)  
Green Nylon

Rocker Moulding Clip  
Head Size: 22mm x 46mm  
Stem Length: 17mm  
Fits Into 10mm Hole

Cadillac 1998 - On  
UNIT PACKAGE: 15

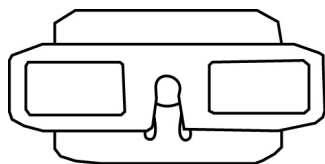

**21491**

(VW: 443-853-909-A)

Front Door, Fender & Quarter Panel

Moulding Clip  
Width: 20mm  
Length: 41.5mm

Natural Nylon  
Audi 1998 - 88

UNIT PACKAGE: 25

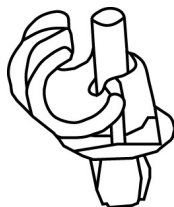

**21483**

(VW: 1H0-823-397)  
Natural Nylon

Hood Prop Rod Clip  
Rod Size: 8mm

Stem Length: 10mm  
Fits Into 7mm Square Hole  
VW 1999 - 93

UNIT PACKAGE: 25

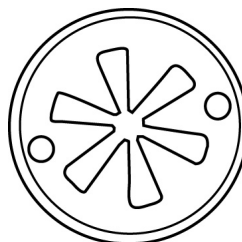

**21485**

(VW: N90-796-501, N90-796-502)  
Dacromet Plated

Radiator Support & Splash Shield  
Push-On Retainer

Stud Size: 5mm  
O.D.: 30mm

VW 2006 - 1999

UNIT PACKAGE: 25

# Revised Popular New Items Display Board puts the hottest new items at your finger tips!

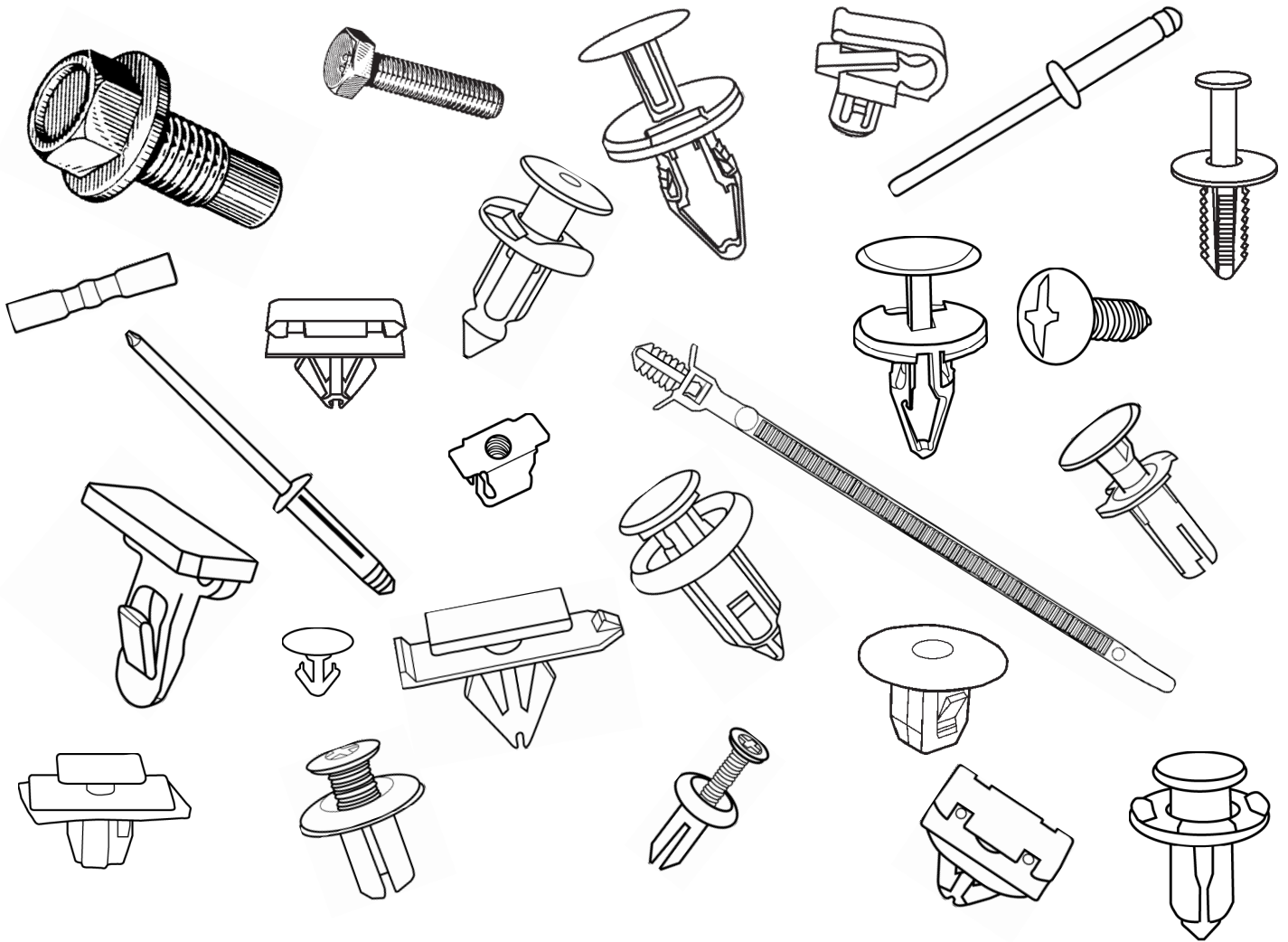

Part No: **DB-PNI**

**Keep up-to-date with what's hot!** The 2012 edition of our Popular New Items Display Board contains the 38 most popular new items we have added to the Auveco line. Make sure your customers know you can supply them with these high demand parts. Products include a retaining clip, push-type retainers, grille moulding clips, moulding clips, screw grommet, specialty rivets, butt connectors, bumper clips, hex flange bolts, license plate screw, cable tie, and retainer nut . The back of the display board contains all the information on O.E.M. numbers, descriptions, specifications, dimensions and Auveco unit package quantities.

# HOT

"Since 1916"

**Qu-ve-co**  
PRODUCTS

HNI-304 3/9/12

## New Item Bulletin

## Items Available For Immediate Shipment

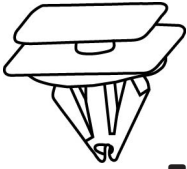

**21522**

Not Available From O.E.M.  
Gray Nylon

Fender & Rocker Moulding Clip With  
Sealer

Top Head Size:  
14mm x 18mm

Bottom Head Size:  
18mm x 21mm

Stem Length: 15mm

Fits Into 9mm Hole

Ford Explorer 2011 - On

UNIT PACKAGE: 25

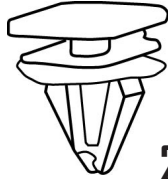

**21523**

Not Available From O.E.M.  
White Nylon

O.E.M. Rocker Moulding Clip With  
Sealer

Top Head Size:  
14mm x 18mm

Bottom Head Size:  
14mm x 18mm

Stem Length: 15mm

Fits Into 9mm Hole

Lincoln MKS 2010 - On

UNIT PACKAGE: 10

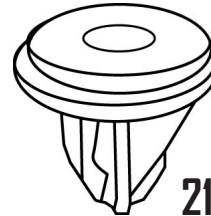

**21518**

(GM: 11561987)  
Black Nylon

Tail Light Grommet  
With Sealer

Head Diameter: 24mm

Stem Length: 22mm

Overall Length: 24.5mm

Cadillac Escalade and Chevrolet  
Avalanche

2011 - 2007

UNIT PACKAGE: 15

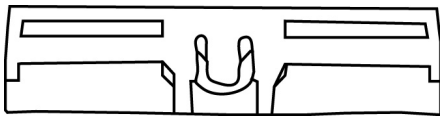

**21505**

(Lexus: 75545-53011)  
Blue Nylon

Windshield Moulding Clip  
Width: 15mm, Length: 55mm

Lexus GX460, IS250/350  
IS F 2006 - On

UNIT PACKAGE: 5



**21484**

(Kia: 87756-3E500)  
Red Nylon

Wheel Flare & Body Side Moulding Clip  
With Sealer

Top Head Size:  
11mm x 13mm

Bottom Head Size:  
12mm x 20mm

Stem Length: 10mm

Kia Forte Koup & Sorrento 2009 - On

UNIT PACKAGE: 15



**21521**

(Honda: 90107-S0X-A01)  
Black Nylon

Screw Grommet

M4.8 (#10) Screw Size  
Head Size: 16mm x 16mm

Stem Length: 7mm

Acura CL, MDX, RL, 3.2 CI & 3.5RI and  
Honda Accord, Pilot, Ridgeline & S2000  
2011 - 1996

UNIT PACKAGE: 25

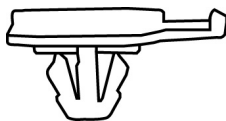

**21512**

(VW: 7L0-839-069)  
White Nylon

Rocker Panel Moulding Clip  
Width: 10mm

Length: 28.5mm

Stem Length: 11mm

Fits Into 10mm Hole

VW Touareg 2010 - 05

UNIT PACKAGE: 25



**21513**

(VW: N90-335-006)

Splash Shield & Wheel Well Push-On  
Retainer

Stud Size 5mm

O.D.: 30mm

Dacromet

VW & Audi

UNIT PACKAGE: 25



**21498**

(VW: 191-941-142)  
White Nylon

Headlight Adjusting Nut  
Head Size: 14mm x 18.5mm

Overall Length: 15mm

Fits Into 10mm Hole

Audi 100 and VW Golf

1994 - 86

UNIT PACKAGE: 25

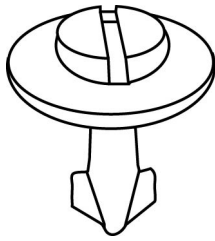

**21515**

Black Nylon

(VW: 4A0-805-121-A)  
Front Fender, Bumper & Engine Cover  
Retainer

Slotted Drive  
Head Diameter: 25mm  
Stem Length: 22mm  
VW Passat & Audi  
2011 - 1992

UNIT PACKAGE: 25

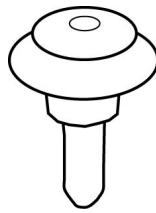

**21516**

(VW: 357-853-585)  
White Nylon

Retainer With Black Nylon Grommet  
Top Head

Diameter: 12mm  
Bottom Head  
Diameter: 18mm  
Stem Diameter: 10mm  
Stem Length: 20mm  
VW Golf A2 & A3 and Audi

UNIT PACKAGE: 25



**21514**

(VW: 6N0-823-397-AC)  
Black Nylon

Hood Prop Rod Clip  
8mm Rod Size  
Head Diameter: 15mm  
Fits Into 7mm Square Hole  
VW & Audi

UNIT PACKAGE: 25

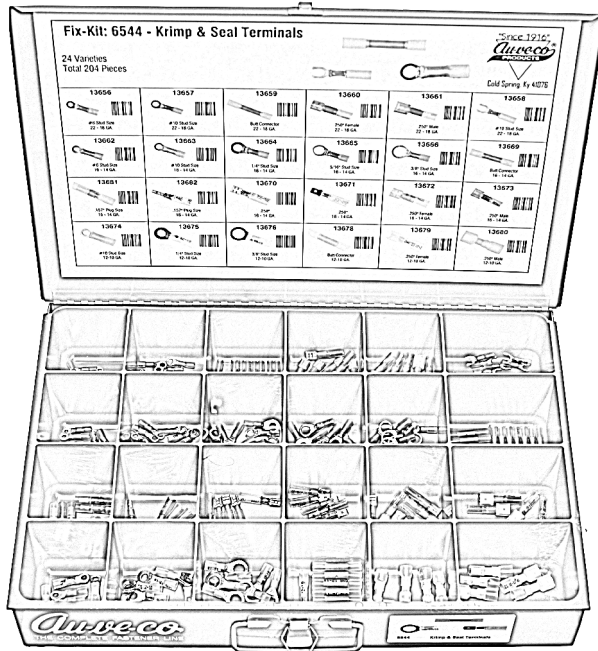
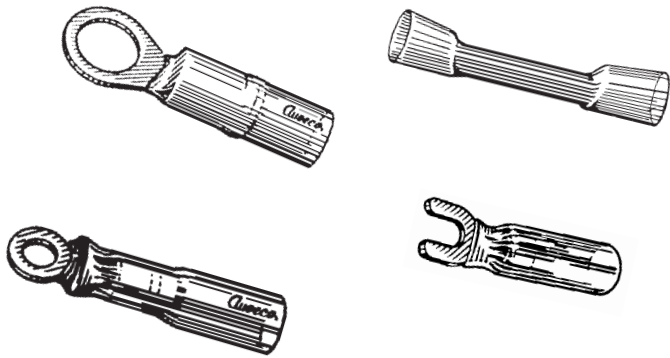

Metal Drawer  
18" Wide x 12" Deep 3" High

## No. 6544 "Fix-Kit"

Krimp & Seal Terminals  
Featuring 3 - 1 Ratio Heat Shrink Tubing  
24 Varieties - 204 Pieces

Auveco  
Part No.

Description

Auveco Part No.	Description
13656	Ring Type, 22-18 Ga.
13657	Ring Type, 22-18 Ga.
13658	Spade Type, 22-18 Ga.
13659	Butt Conn., 22-18 Ga.
13660	Female Q.C. 22-18 Ga.
13661	Male Q.C., 22-18 Ga.
13662	Ring Type, 16-14 Ga.
13663	Ring Type, 16-14 Ga.
13664	Ring Type, 16-14 Ga.
13665	Ring Type, 16-14 Ga.
13666	Ring Type, 16-14 Ga.
13669	Butt Conn., 16-14 Ga.
13670	Female Q.C., 16-14 Ga.
13671	Male Q.C., 16-14 Ga.
13672	Female Q.C., 16-14 Ga.
13673	Male, Q.C., 16-14 Ga.
13674	Ring Type, 12-10 Ga.
13675	Ring Type, 12-10 Ga.
13676	Ring Type, 12-10 Ga.
13678	Butt Conn., 12-10 Ga.
13679	Female Q.C., 12-10 Ga.
13680	Male Q.C., 12-10 Ga.
13681	Female Plug, 16-14 Ga.
13682	Male Plug, 16-14 Ga.

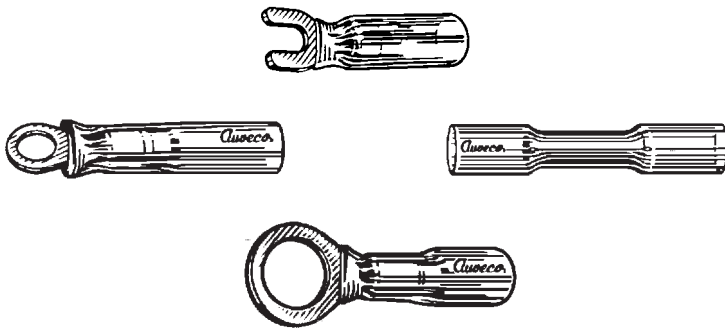

# No. 21534

Krimp & Seal Terminals  
Featuring 3 - 1 Ratio Heat Shrink Tubing  
24 Varieties - 204 Pieces

Auveco  
Part No. Description

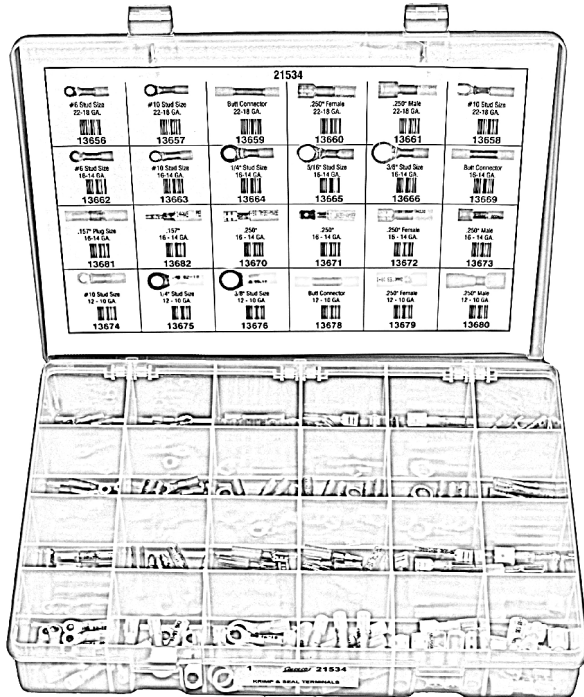

- 13656 Ring Type, 22-18 Ga.
- 13657 Ring Type, 22-18 Ga.
- 13658 Spade Type, 22-18 Ga.
- 13659 Butt Conn., 22-18 Ga.
- 13660 Female Q.C. 22-18 Ga.
- 13661 Male Q.C., 22-18 Ga.
- 13662 Ring Type, 16-14 Ga.
- 13663 Ring Type, 16-14 Ga.
- 13664 Ring Type, 16-14 Ga.
- 13665 Ring Type, 16-14 Ga.
- 13666 Ring Type, 16-14 Ga.
- 13669 Butt Conn., 16-14 Ga.
- 13670 Female Q.C., 16-14 Ga.
- 13671 Male Q.C., 16-14 Ga.
- 13672 Female Q.C., 16-14 Ga.
- 13673 Male, Q.C., 16-14 Ga.
- 13674 Ring Type, 12-10 Ga.
- 13675 Ring Type, 12-10 Ga.
- 13676 Ring Type, 12-10 Ga.
- 13678 Butt Conn., 12-10 Ga.
- 13679 Female Q.C., 12-10 Ga.
- 13680 Male Q.C., 12-10 Ga.
- 13681 Female Plug, 16-14 Ga.
- 13682 Male Plug, 16-14 Ga.

Translucent Durable  
Polypropylene Box  
13-1/16" x 8-13/16" x 2-1/4"



"Since 1916"



HNI-305 3/23/12

# New Item Bulletin

# Items Available For Immediate Shipment

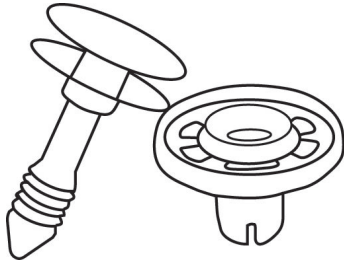

## 21535

(GM: 11571118)  
White Nylon

Door Panel Retainer & Grommet  
Retainer Top Head  
Diameter: 19.5mm  
Retainer Bottom Head  
Diameter: 19.5mm  
Retainer Stem Length: 26mm  
Grommet Flange Diameter: 24mm  
Grommet Stem Length: 12mm  
Fits Into 9mm Hole  
Buick Enclave & Lucerne, Cadillac DTS,  
Chevrolet Traverse, GM "G" Vans,  
GMC Acadia and Hummer H2  
2008 - On

UNIT PACKAGE: 15

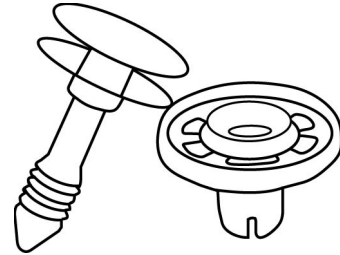

## 21536

(GM: 11571119)  
Yellow Nylon

Door Panel Retainer & Grommet  
Retainer Top Head Diameter: 19.5mm  
Retainer Bottom Head  
Diameter: 19.5mm  
Retainer Stem Length: 26mm  
Grommet Flange Diameter: 24mm  
Grommet Stem Length: 12mm  
Fits Into 9mm Hole  
Buick Enclave & Lucerne, Cadillac DTS,  
Chevrolet Cobalt, Colorado, Traverse,  
GM "G" Vans, GMC Acadia & Canyon and  
Pontiac G5 & Pursuit  
2008 - On

UNIT PACKAGE: 15

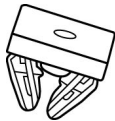

## 21524

(GM: 11610157)  
Zinc Organic

Center Console  
Door, Front Lights, Grille, Instrument  
Panel & Lift Gate Nut With Silicone Pad  
M4.2-1.41 (#8) Screw Size  
Cadillac CTS, Chevrolet Corvette,  
Equinox, Malibu & Traverse, Hummer  
H3, Pontiac G6 and Saturn Ion  
2012 - 2003

UNIT PACKAGE: 10

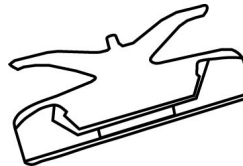

## 21526

(Not Available From O.E.M.)  
White Nylon

Windshield Moulding Clip  
Head Size: 14.5mm x 30mm  
Bottom Leg Width: 26mm  
Ford Flex 2009 - On

UNIT PACKAGE: 25

### New Application Information

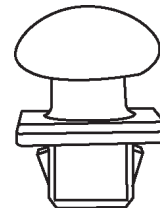

## 20936\*

(Ford: W707388-S300;  
Mazda: 9XG0-73-88X0)  
Black Nylon

Front Bumper Cover  
Moulding Clip  
Bottom Head Size: 18mm x 20mm  
Stem Length: 10mm  
Fits Into 8mm x 12mm Hole  
Ford Escape 2001 - On  
Mazda Tribute 2006 - 2001

UNIT PACKAGE: 10

\*Not a new item



**21520**

(Mazda: J001-56-741)  
Black Nylon

Weatherstrip Retaining Clip

Head Diameter: 14mm

Stem Diameter: 6.5mm

Stem Length: 10mm

Mazda CX-7, Millenia, MPV, 3, 6 & 626  
2011 - 1995

UNIT PACKAGE: 25

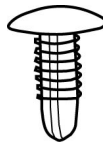

**21519**

(Nissan: 01553-01A50)  
Black Nylon

Bumper & Trim Retainer

Head Diameter: 12mm

Stem Diameter: 6mm

Stem Length: 15mm

Infiniti FX35, G35, G37, M35, M45 &  
Q45 and Nissan 350Z & 370Z  
2011 - 1997

UNIT PACKAGE: 25

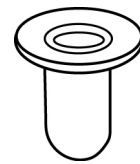

**21499**

(BMW: 51-44-7-780-135)  
(Mercedes-Benz: 108-988-00-27)  
Natural Nylon

Tubular Nut

Stud Size: 7mm

Head Diameter: 16mm

Stem Length: 16mm

Fits Into 8.5mm Hole

BMW, Mercedes-Benz & Universal

UNIT PACKAGE: 25

## Ball Joint Assemblies

**(Lightweight)**

Materials of construction - Made of low carbon steel. Units are plated and dichromate treated for corrosion resistance. A rubber disc is used

Only Available Fully Assembled.



**21533 replaces Auveco part number 13606**

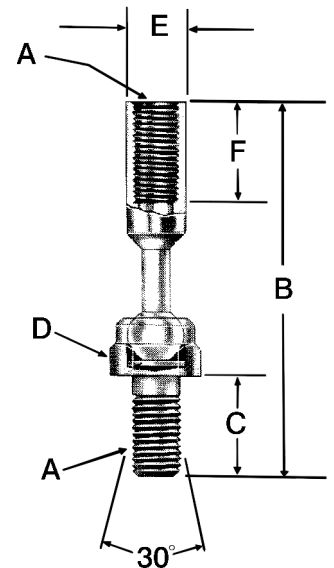

Auveco Part No.	Unit Package	GM	A	B	C	D	E	F
<b>21533</b>	2	443773	1/4"-28	2-3/32"	9/16"	7/16"	5/16"	9/16"

# HOT

"Since 1916"  
**Au-ve-co**<sup>®</sup>  
PRODUCTS

HNI-307 4/20/12

## New Item Bulletin

## Items Available For Immediate Shipment

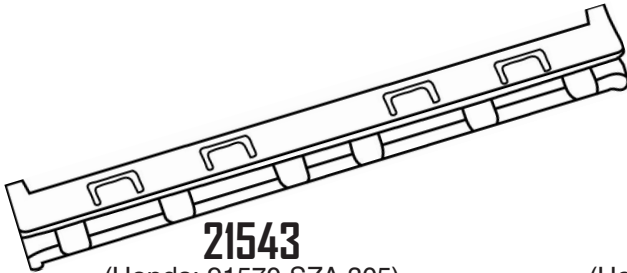

**21543**

(Honda: 91570-SZA-305)  
Blue Nylon

Windshield Moulding Clip With  
Adhesive Backing  
Width: 8mm  
Length: 82mm  
Acura ZDX and Honda Odyssey & Pilot  
2009 - On

UNIT PACKAGE: 5



**21555**

(Honda: 91512-S50-003)  
White Nylon

License Plate Garnish & Trim  
Moulding Clip With Sealer  
Top Head Size: 12mm x 17mm  
Bottom Head Size: 16mm x 17mm  
Stem Diameter: 13mm  
Stem Length: 12mm  
Acura TSX & ZDX and Honda Accord,  
Civic, Crosstour, Fit, Insight  
Odyssey & Pilot 2012 - 01

UNIT PACKAGE: 25



**21556**

(Honda: 75305-SM4-A01)  
White Nylon

Fender Trim Moulding Clip  
Head Size: 13mm x 15mm  
Stem Length: 15mm  
Honda Accord & Civic 2000 - 1990  
UNIT PACKAGE: 25



**21557**

(Honda: 75316-S9A-004)  
White Nylon

Door Trim Moulding Clip  
Head Size: 14mm x 16mm  
Stem Length: 12mm  
Fits Into 10mm Hole  
Acura RDX and Honda CR-V  
2012 - 02

UNIT PACKAGE: 25



**21558**

(Honda: 91504-SP1-003)  
White Nylon

Rocker Panel & Fender  
Moulding Clip With Sealer  
Top Head Size: 16mm x 18mm  
Bottom Head Size: 18mm x 20mm  
Stem Length: 15mm  
Fits Into 10mm Hole  
Acura Legend, MDX, RL & ZDX and  
Honda Civic, CR-V & Odyssey  
2012 - 1991

UNIT PACKAGE: 25



**21559**

(Honda: 91512-SJ6-J01)  
Black Nylon

Rocker Panel, Tail Light & License Plate  
Housing Garnish Moulding Clip  
With Sealer  
Top Head Size: 9mm x 12mm  
Bottom Head Diameter: 13mm  
Stem Diameter: 7.5mm  
Stem Length: 9mm  
Acura TSX and Honda Civic & CR-V  
2011 - 1997

UNIT PACKAGE: 25

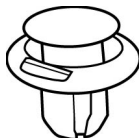

**21547**

(Toyota: 90467-09185)  
Black Nylon

Front Spoiler & Grille  
Push-Type Retainer  
Head Diameter: 18mm  
Stem Length: 10mm  
Fits Into 9mm Hole  
Lexus HS 250h and Toyota Celica,  
Sequoia, Sienna & 4-Runner  
2012 - 1994

UNIT PACKAGE: 25



**21548**

(Toyota: 67869-20030)  
Black Nylon

Weatherstrip Retainer  
Head Diameter: 10mm  
Stem Diameter: 6mm  
Stem Length: 10mm  
Lexus IS 300 & SC 430 and Toyota  
Camry, Celica, Corolla, Highlander,  
Matrix, MR-2, Prius, RAV-4, Scion,  
Solara & Supra  
2012 - 1990

UNIT PACKAGE: 25



**21551**

(Toyota: 67869-12050)  
Black Nylon

Weatherstrip Retainer  
Top Head Diameter: 9mm  
Bottom Head Diameter: 12mm  
Stem Diameter: 7mm  
Stem Length: 13mm  
Toyota Corolla & Prius  
2007 - 01

UNIT PACKAGE: 25





### 21552

(Toyota: 90467-04034)  
White Nylon

Weatherstrip Retainer

Top Head Size: 5mm x 15mm

Bottom Head Diameter: 9mm

Stem Diameter: 6.5mm

Stem Length: 4mm

Lexus CT 200h, HS 250h, IS F, IS 250, IS 350, LS 460, LS 600h, RX 350, RX 400h & RX 450h and Toyota Avalon, Corolla, Highlander, Matrix, Prius, RAV-4, Scion & Venza  
2012 - 03

UNIT PACKAGE: 25

Not Actual Size

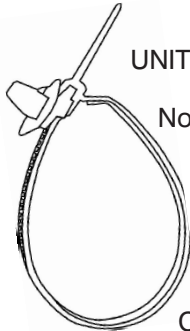

### 21553

(Toyota: 82711-12200)  
Black Nylon

Cable Strap

Length: 170mm (6-3/4")

Width: 7mm (7/32")

Maximum Bundle

Diameter: 40mm (1-9/16")

Toyota Camry, Celica, Corolla, Cressida, Land Cruiser, MR-2, Paseo, Previa, RAV-4, Supra, T-100, Tercel & 4-Runner 1998 - On

UNIT PACKAGE: 25



### 21545

(Nissan: 01553-08231)  
Black Nylon

Front & Rear Bumper and Grille Push-Type Retainer

Head Diameter: 20mm

Stem Length: 15mm

Fits Into 8mm Hole

Infiniti FX35, FX45 & Q45 and Nissan Murano, 240 SX & 350Z  
2011 - 1995

UNIT PACKAGE: 25

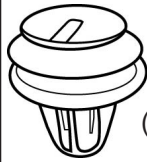

### 21554

(Honda: 91560-S7A-003)  
Black Nylon

Trim Panel Retainer With Sealer

Top Head Diameter: 13mm

Middle Head Diameter: 16mm

Bottom Head Diameter: 15mm

Stem Diameter: 9.5mm

Stem Length: 11mm

Honda Crosstour, Fit & Odyssey  
2010 - 05

UNIT PACKAGE: 25



### 21546

(Toyota: 90467-09204)  
White Nylon

Rear Hatch Door Side Garnish and Front Body Pillar Garnish Moulding Clip  
Overall Height: 14mm

Lexus GS 300, GS 400, GS 430, GX 470, RX 330, RX 350, RX 400 & RX 450 and Toyota Camry, Highlander, Prius & Sienna  
2012 - 1998

UNIT PACKAGE: 25

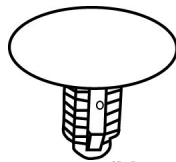

### 21560

(Mazda: G032-68-865A-00)  
Black Nylon

Trunk & Carpet Retainer

Head Diameter: 20mm

Stem Diameter: 7mm

Stem Length: 15mm

Mazda B2000, B2600, CX-7, CX-9, Miata, Millenia, MX-3, MX-5, MX-6, Protege, RX-7, RX-8, 3, 5, 6, 626 & 929  
2012 - 1987

UNIT PACKAGE: 25



### 21549

(Toyota: 90467-12080)  
Pink Nylon

Door Trim, Instrument Panel, Rear Deck Trim & Roof Garnish Trim Moulding Clip  
Overall Height: 21mm

Lexus ES 350, GX 460, RX 330 & RX 450h and Toyota Avalon, Camry, Corolla, Echo, FJ Cruiser, Highlander, Matrix, Prius, RAV 4, Sequoia, Sienna, Tacoma, Tundra, Venza, Yaris & 4-Runner  
2012 - 2000

UNIT PACKAGE: 25

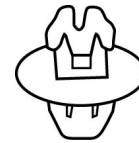

### 21550

(Toyota: 90467-11099)  
White Nylon

Hood and Front & Rear Side Moulding Clip

Head Diameter: 17mm

Stem Length: 8.5mm

Fits Into 9mm Square Hole  
Toyota Tundra & 4-Runner  
2006 - 1996

UNIT PACKAGE: 25

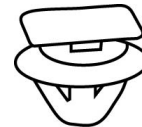

### 21561

(Mazda: E11451W24)  
White Nylon

Moulding Clip

Top Head Size: 10mm x 15mm

Bottom Head Diameter: 17mm

Stem Diameter: 13mm

Stem Length: 9mm

Mazda CX-7 2012 - 07

UNIT PACKAGE: 25

# HOT

"Since 1916"  
**Qu-ve-co**<sup>®</sup>  
PRODUCTS

HNI-301 11/25/11

## New Item Bulletin

## Items Available For Immediate Shipment

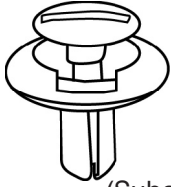

**21500**

(Subaru: 90914-0063)  
Black Nylon

Cowl Vent Push-Type Retainer  
Head Diameter: 20mm  
Stem Length: 12mm  
Fits Into 7mm Hole

Subaru Legacy & Outback 2010 - On

UNIT PACKAGE: 10

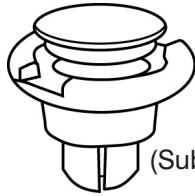

**21501**

(Subaru: 90914-0055)  
Black Nylon

Rocker Moulding  
Push-Type Retainer With Sealer  
Head Diameter: 25mm  
Shoulder Length: 3mm  
Shoulder Diameter: 16.5mm  
Stem Length: 12mm  
Fits Into 11mm Hole

Subaru B9 Tribeca, Forrester, Impreza,  
Legacy & Outback 2006 - On

UNIT PACKAGE: 5

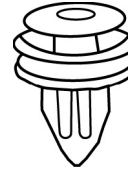

**21502**

(Subaru: 90913-0213)  
White Nylon

Door Trim Panel Retainer With Sealer  
Top Head Diameter: 13mm  
Middle Head Diameter: 16mm  
Bottom Head Diameter: 15mm  
Stem Diameter: 9.5mm  
Stem Length: 14mm

Subaru Legacy & Outback 2010 - On

UNIT PACKAGE: 10

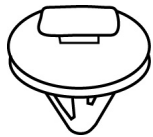

**21453**

(Toyota: 75395-0T010)  
White Nylon

Moulding Clip With Sealer  
Top Head Size: 5mm x 10mm  
Bottom Head Diameter: 18mm  
Stem Diameter: 10mm  
Stem Length: 13mm

Toyota Corolla & Venza 2011-08

UNIT PACKAGE: 25



**21470**

(Honda: 75306-SZA-A01)  
White Nylon

Moulding Clip  
Top Head Size: 7.5mm x 10mm  
Bottom Head Size: 9.5mm  
Overall Height: 16mm  
Honda Pilot 2011 - 09

UNIT PACKAGE: 15

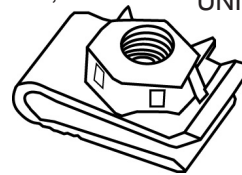

**21459**

(Nissan: 01241-00881)  
Black Nylon

Nylon "U" Nut With Captive  
Metal Hex Nut  
M6 - 1.0 Thread  
Center Of Hole To Edge: 14mm  
Panel Range: Up To 4mm  
Nissan Altima, Maxima & 240SX and  
Infiniti I30 2001 - 1993

UNIT PACKAGE: 10

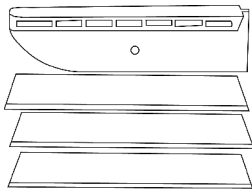

Not Actual Size

**21511**

Three replacement cutting blades  
and one anvil for Moulding  
Cutting Tool 15748 (catalog page 637).  
Replaces 15750 Cutting Blades  
and 15751 Anvil.

UNIT PACKAGE: 1 Kit



**21452**

(VW: 1H0-819-055-C01C)  
Black Nylon

Push-Type Retainer  
Top Head Diameter: 23mm  
Bottom Head Diameter: 16mm  
Stem Length: 15mm  
Fits Into 8mm x 8mm Square Hole  
VW 2002 - 1993

UNIT PACKAGE: 25

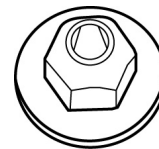

**21456**

(VW: 171-201-969)  
Black Nylon

Moulding Nylon Flange Nut  
Stud Size: 5mm  
Hex: 10mm  
Flange Diameter: 18.5mm  
Overall Height: 10.5mm  
Audi A8, S8 & 90 2003 - 1993

UNIT PACKAGE: 25

# HOT

"Since 1916"

**Au-ve-co**<sup>®</sup>  
PRODUCTS

HNI-302 12/9/11

## New Item Bulletin

## Items Available For Immediate Shipment

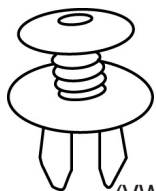

**21479**

(VW: 701-867-299)  
Gray Nylon

Front Bumper & Interior Trim  
Push-Type Retainer  
With 3mm Allen Head Drive  
Head Diameter: 18.5mm  
Stem Length: 11mm  
Fits Into 9mm Hole  
VW Jetta & Passat 2011 - 1999  
UNIT PACKAGE: 25

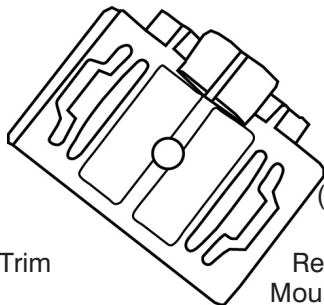

**21481**

(Audi: 4A0-853-825-C)  
White Nylon

Rear Door  
Moulding Clip  
Width: 26mm  
Length: 34.5mm  
Stem Length: 6mm  
Audi 100, A6, S4, S6 & Quattro  
1998 - 92  
UNIT PACKAGE: 25

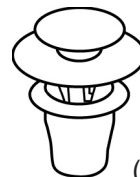

**21509**

(VW: 357-853-575)  
White Nylon

Retainer With Gray Grommet  
Top Head Diameter: 12mm  
Bottom Head Diameter: 18mm  
Stem Diameter: 10mm  
Stem Length: 16mm  
VW Golf, Jetta, Passat & Scirocco  
UNIT PACKAGE: 25



**21478**

(VW: 3A0-853-575)  
White & Orange Nylon

Door, Fender & Quarter Panel  
Moulding Clip  
Width: 35mm  
Length: 38mm  
Stem Length: 14mm  
With Blue Rubber Boot Volkswagen  
1997 - 90  
UNIT PACKAGE: 15

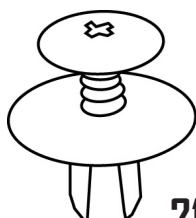

**21482**

(VW: 1H0-867-199-A)  
Black Nylon

Push-Type Retainer  
Head Diameter: 24mm  
Stem Length: 13mm  
Fits Into 9mm Square Hole  
VW Passat 1999 - 90  
UNIT PACKAGE: 25



**21508**

(VW: 191-853-577)  
White Nylon

Door Trim & Scuff Plate Moulding Clip  
Head Size: 12mm x 15mm  
Stem Diameter: 10mm  
Stem Length: 19mm  
Audi A1 & A2 and VW Golf & Jetta  
UNIT PACKAGE: 25

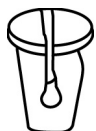

**21480**

(VW: 165-827-592)  
Natural Nylon

Screw Grommet  
M4.2 (#8) Screw Size  
Head Diameter: 11mm  
Stem Length: 13mm  
VW Cabrio, EuroVan, Golf, Jetta  
2003 - 1992  
UNIT PACKAGE: 25



**21510**

(VW: 867-809-966, 811-807-557-C)  
Black Nylon

Screw Grommet  
Screw Size: M4.8 (#10)  
Head Diameter: 12mm  
Stem Length: 12.5mm  
VW & Audi  
UNIT PACKAGE: 25